



Federal Ministry
for Economic Affairs
and Energy



中国国家标准化管理委员会
Standardization Administration of the P.R.C.



中华人民共和国工业和信息化部

Alignment Report for Reference Architectural Model for Industrie 4.0/ Intelligent Manufacturing System Architecture

*Sino-German Industrie 4.0/Intelligent Manufacturing
Standardisation Sub-Working Group*

Imprint

Publisher

Federal Ministry of Economic Affairs and Energy
Department of Public Relations
11019 Berlin
www.bmwi.de

Text

Standardization Council Industrie 4.0
DKE Deutsche Kommission Elektrotechnik
Elektronik Informationstechnik in DIN und VDE,
60596 Frankfurt am Main

Design and production

AKRYL digital agency, Hamburg

Status

April 2018

This brochure is published as part of the public relations work of the Federal Ministry for Economic Affairs and Energy. It is distributed free of charge and is not intended for sale. The distribution of this brochure at campaign events or at information stands run by political parties is prohibited, and political party-related information or advertising shall not be inserted in, printed on, or affixed to this publication.



The Federal Ministry for Economic Affairs and Energy was awarded the audit berufundfamilie® for its family-friendly staff policy. The certificate is granted by berufundfamilie gGmbH, an initiative of the Hertie Foundation.

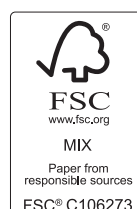

Background

In May 2015, China and Germany jointly set up the Sub-Working Group Intelligent Manufacturing/ Industrie 4.0 of the Sino-German Standardisation Cooperation Commission (Working Group). Later in December 2015, the first Working Group conference was held in Shanghai and a constructive suggestion of mutually recognizing the Reference Architecture Model for Industry 4.0 (RAMI4.0) and China Intelligent Manufacturing System Architecture

(IMSA) was proposed and confirmed. In May 2016, the second conference was held in Leipzig, Germany and experts from China and Germany deeply discussed the way to mutually recognize the RAMI4.0 and IMSA. In November 2016, the third conference was held in Berlin, a consensus on Sino-German Intelligent Manufacturing/Industrie 4.0 System Architecture was achieved and an alignment result was initially shaped.

IMSA

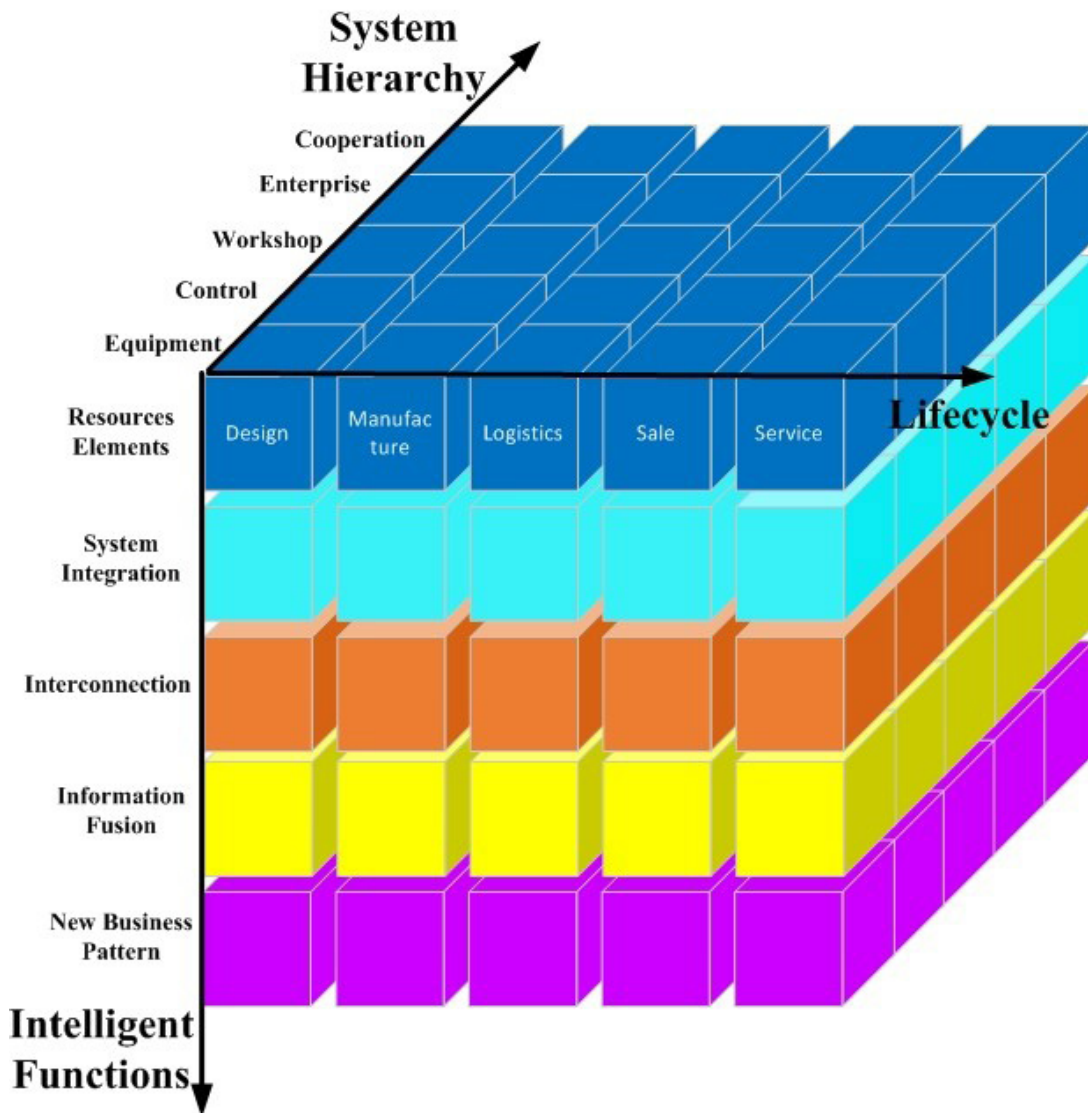

Fig. 1 Intelligent Manufacturing System Framework

IMSA is constructed from three dimensions such as lifecycle, system hierarchy and intelligent functions, as shown in Fig. 1.

1. Lifecycle

Lifecycle refers to a series of mutually connected value creation activities of the stages from the product prototype research and development to product recycling and remanufacturing, including design, manufacture, logistics, sales and service. Iterative optimization can be conducted for the lifecycle activities with the characteristics such as sustainable development, and the lifecycle components of different industries.

1. Design means the process in which the construction, simulation, verification, optimization and other research and development activities are conducted according to all demands by the enterprise and the constraints of the selected technology;
2. Manufacturing means the process by which the required goods are created by labor;
3. Logistics refers to the process by which the goods are transported to their destinations;
4. Sale means the business activity in which the products or commodities are transferred from the enterprise to the clients;
5. Service means a series of the activities and their corresponding results generated during the communication between the service providers and the clients, which includes, for example, recycling.

2. System hierarchy

System hierarchy means the hierarchy division of the organizational structure related to the enterprise's manufacturing activities. This includes equipment hierarchy, control hierarchy, workshop hierarchy, enterprise hierarchy and cooperation hierarchy.

1. Equipment hierarchy means the hierarchy in which the enterprise utilizes the sensor, instrument and meter, machine and device to realize, perceive and control the physical process;
2. The control hierarchy is a hierarchy used to achieve information processing in the factory and to monitor and control physical processes;
3. The workshop hierarchy is a hierarchy used to structure manufacture and management in the factory or workshop;
4. The enterprise hierarchy is a hierarchy used to structure effective enterprise management;
5. The cooperation hierarchy is a hierarchy used to structure the interconnection and sharing process of internal and external information by the enterprise.

3. Intelligent Functions

Based on the new-generation information and communication technology, manufacturing activities have been strengthened with one or more intelligent functions, namely the intelligent functions, and ultimately reach the goal of self-sensing, self-learning, self-decision, self-execution, and self-adaptation. The intelligent functions include resources elements, interconnection and interworking, information fusion, system integration and new business pattern. Specifically,

1. Resources elements refer to a hierarchy used to achieve the digital process with resources or tools by the enterprise during the manufacturing process;
2. Interconnection and interworking refers to a hierarchy used to connect equipment, equipment and control system, between enterprises through wired, wireless and other communication technology;
3. Information fusion refers to a hierarchy used to achieve collaborative information sharing with cloud computing, big data and other new generation of information. This further includes communication technology based on the interconnection and interworking to ensure the information safety;
4. System integration refers to a hierarchy used to achieve integration of intelligent equipment in the intelligent production unit, intelligent production line, digital workshop, intelligent factory, and even intelligent manufacturing system by the enterprise;
5. The new business pattern refers to a hierarchy used to perform value chain integration between enterprises to form new industry conformations by the enterprise.

The key of intelligent manufacturing is to achieve vertical integration through the enterprise equipment hierarchy, control hierarchy, workshop hierarchy, factory hierarchy, cooperation hierarchy at different hierarchies, the horizontal integration across resources, interconnection and interworking, information fusion, system integration and new business pattern at different hierarchies, as well as the end-to-end integration of covering design, manufacture, logistics, sales and service.

RAMI 4.0

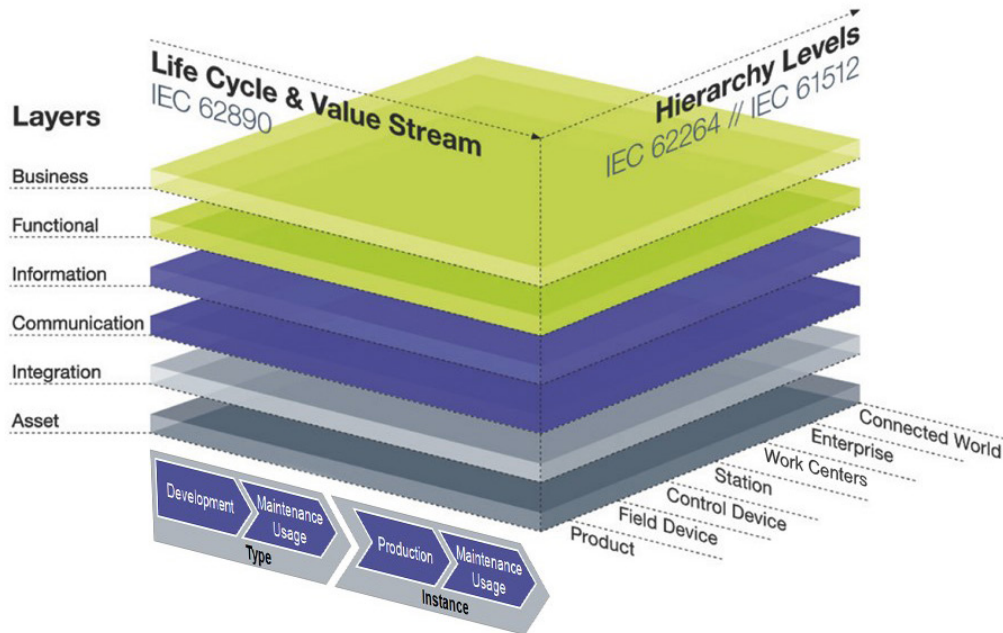

Fig. 2 Reference Architecture Model for Industrie 4.0.

RAMI 4.0 is constructed from three dimensions such as Layers, Life Cycle & Value Stream and Hierarchy Levels, as shown in Fig. 2.

1. Layers

Layers are used in the vertical axis to represent the various perspectives, such as data maps, functional descriptions, communications behavior, hardware/ assets or business processes. This corresponds to IT thinking where complex projects are split up into clusters of manageable parts.

(1) Business Layer

- Ensures the integrity of the functions in the value stream.
- Maps out the business models and the resulting overall process.
- Provides legal and regulatory framework conditions.
- Models of the rules which the system has to follow.
- Orchestrates services in the Functional Layer.
- Provides a link between different business processes.
- Receives events for advancing of the business processes.

The Business Layer does not concern concrete systems, such as an ERP system. ERP functions in the process con-

text are typically located in the Functional Layer.

(2) Functional Layer

- Formal description of functions.
- Platform for horizontal integration of the various functions.
- Run time and modelling environment for services which support business processes.
- Run time environment for applications and technical functionality.

Rules and decision-making logic are generated inside the Functional Layer. Depending on the use case, these can also be executed in the lower layers (Information Layer or Integration Layer).

Remote access and horizontal integration only take place within the Functional Layer. This ensures the integrity of the information and conditions in the process and the integration of the technical level. The Asset Layer and Integration Layer may also be accessed temporarily for maintenance purposes.

Such access is in particular used to call up information and processes which are only relevant to subordinate layers. Examples include flashing of sensors/actuators or the reading

of diagnosis data. This maintenance-related, temporary remote access is not relevant to permanent functional or horizontal integration.

(3) Information Layer

Run time environment for (pre-) processing of events.
Execution of event-related rules.
Formal description of rules.
Context: event pre-processing.

In that context, rules are applied to one or more events to generate one or more further events, which then initiate processing in the Functional Layer.

- Persistence of the data which represent the models.
- Ensuring data integrity.
- Consistent integration of different data.
- Obtaining new, higher quality data (data, information, knowledge).
- Provision of structured data via service interfaces.
- Receiving of events and their transformation to match the data which are available for the Functional Layer.

(4) Communication Layer

Standardisation of communication, using a uniform data format, in the direction of the Information Layer.
Provision of services for control of the Integration Layer.

(5) Integration Layer

Provision of information on the assets (physical components / hardware / documents / software, etc.) in a form which can be processed by computer.
Computer-aided control of the technically process.
Generation of events from the assets.
Contains the elements connected with IT, such as RFID readers, sensors, HMI, etc.
Interaction with humans also takes place on this level, for instance via the Human Machine Interface (HMI).

(6) Asset Layer

Represents reality, e. g. physical components such as linear axes, metal parts, documents, circuit diagrams, ideas and archives.
Human beings are also part of the Asset Layer, and are connected to the virtual world via the Integration Layer.
Passive connection of the assets to the Integration Layer, for instance by means of QR codes.

2. Life Cycle & Value Stream

A further important criterion is the product life cycle with the value streams it contains. This is displayed along the left-hand horizontal axis. Dependencies, e. g. constant data acquisition throughout the life cycle, can therefore also be represented well in the reference architecture model.

(1) Life Cycle

Industrie 4.0 offers great potential for improvement throughout the life cycle of products, machines, factories, etc. In order to visualize and standardize Relationships and links, the second axis of the reference architecture model represents the life cycle and the associated value streams.

The draft of IEC 62890 is a good guideline for consideration of the life cycle. The fundamental distinction between type and instance is of central importance in those considerations.

a. Type

A type is always created with the initial idea, i.e. as a product comes into being in the development phase. This covers the placing of design orders, development and testing up to the first sample and prototype production. The type of the product, machine, etc. is thus created in this phase. On conclusion of all tests and validation, the type is released for series production.

b. Instance

Products are manufactured industrially on the basis of the general type. Each manufactured product then represents an instance of that type, and, for example, has a unique serial number. The instances are sold and delivered to customers. For the customer, the products are initially once again only types. They become instances when they are installed in a particular system. The change from type to instance may be repeated several times.

Improvements reported back to the manufacturer of a product from the sales phase can lead to an amendment of the type documents. The newly created type can then be used to manufacture new instances. Similarly to each individual instance, then, the type is also subject to use and updating.

Value Streams

Digitization and linking of the value streams in Industrie 4.0 provides huge potential for improvement. Links spanning various functions are of decisive importance in this

connection. Logistics data can be used in assembly and intralogistics organize themselves on the basis of the order backlog. Purchasing sees inventories in real time, and knows where parts from suppliers are at any given moment. The customer sees the completion status of the product ordered during production, and so on. The linking of purchasing, order planning, assembly, logistics, maintenance, the customer and suppliers, etc., provides great improvement potential. The life cycle therefore has to be viewed together with the value-adding processes it contains, and not in an isolated fashion with a view to a single factory, but rather in the collective of all the factories and all the parties involved, from engineering through component suppliers to the customer.

3. Hierarchy Levels

The third important criterion, represented in the third (right-hand horizontal) axis, is the location of functionalities and responsibilities within the factories/plants. This represents a functional hierarchy, and not the equipment classes or hierarchical levels of the classical automation pyramid.

The third axis of the reference architecture model describes the functional classification of various circumstances within Industrie 4.0. The issue here is not implementation, but solely functional assignment. For classification within a

factory, this axis of the reference architecture follows the IEC 62264 and IEC 61512 standards (see figure 2). For a uniform consideration covering as many sectors as possible from process industry to factory automation, the terms “Enterprise”, “Work Unit”, “Station” and “Control Device” were selected from the options listed there and used.

For Industrie 4.0, not only the control device (e. g. head controller) is decisive, but also considerations within a machine or system. Consequently, the “Field Device” has been added below the Control Device. This represents the functional level of an intelligent field device, e. g. a smart sensor. Furthermore, not only the plant and machinery for the manufacture of products is important in Industrie 4.0, but also the product to be manufactured itself. It has therefore been added as “Product” as the bottom level. As a result, the reference architecture model permits homogeneous consideration of the product to be manufactured and the production facility, with their interdependencies.

An addition has also been made at the upper end of the hierarchy levels. The two IEC standards mentioned only represent the levels within a factory. Industrie 4.0, however, goes a step further and also describes the group of factories, and the collaboration with external engineering firms, component suppliers and customers, etc. For observations above and beyond the Enterprise level, the “Connected World” has therefore been added.

Alignment Result of IMSA and RAMI 4.0

In the following, we address the alignment result of IMSA and RAMI 4.0 by comparing the three dimensions of two reference models. Many similarities can be found between both models.

Firstly, with respect to the Life Cycle and Value Stream dimension on RAMI 4.0 and Lifecycle dimension on IMSA, both reference models consider the process from product prototype development to recycling. Specifically, the development and maintenance usage phases of Type in RAMI 4.0 are corresponding to the design phase in IMSA; the production phase of Instance in RAMI 4.0 are corresponding to both the manufacturing phase and the logistics phase in IMSA; as well as the maintenance usage phase of Instance in RAMI 4.0 are corresponding to the service phase in IMSA. The marketing phase on IMSA is not considered in RAMI 4.0.

Secondly, with respect to the Hierarchy Levels dimension on RAMI 4.0 and Hierarchy dimension on IMSA, both reference models consider organization structure of production related activities according to IEC 62264 and also the extension of the smart factory to the outer space, i.e., the collaboration with external engineering firms, component suppliers and customers. Specifically, both the Product phase and the Field Device phase on RAMI 4.0 are corresponding to the Equipment phase on IMSA. Here, the equipment ap-

plied to produce is also considered as a product to the supplier. There is no explicit description of product phase on IMSA. The Control device phase on RAMI 4.0 are corresponding to the Control phase on IMSA. Both the Station phase and the Work Centers phase on RAMI 4.0 are corresponding to the Factory phase on IMSA. The enterprise phase on RAMI 4.0 is corresponding to the enterprise phase on IMSA addressing the ERP and PLM, etc. While the Connected World phase on RAMI 4.0 is corresponding to the Cooperation phase on IMSA.

Thirdly, with respect to the Layers dimension on RAMI 4.0 and Intelligent Function dimension on IMSA, both reference models consider the influences and improvements of manufacturing from the IT point of view. Specifically, the Asset phase on RAMI 4.0 is corresponding to the resource elements on IMSA; the Integration phase on RAMI 4.0 is corresponding to the System Integration on IMSA; the Communication phase on RAMI 4.0 is corresponding to the Interconnection on IMSA; the Information phase on RAMI 4.0 is corresponding to the Information Fusion phase on IMSA; while both the Functional phase and Business phase on RAMI 4.0 are corresponding to the New Business phase on IMSA. According to Section II, the IMSA pays more attention on IT realizations to accelerate manufacturing improvement.

Compare RAMI 4.0 – Systemarchitecture China

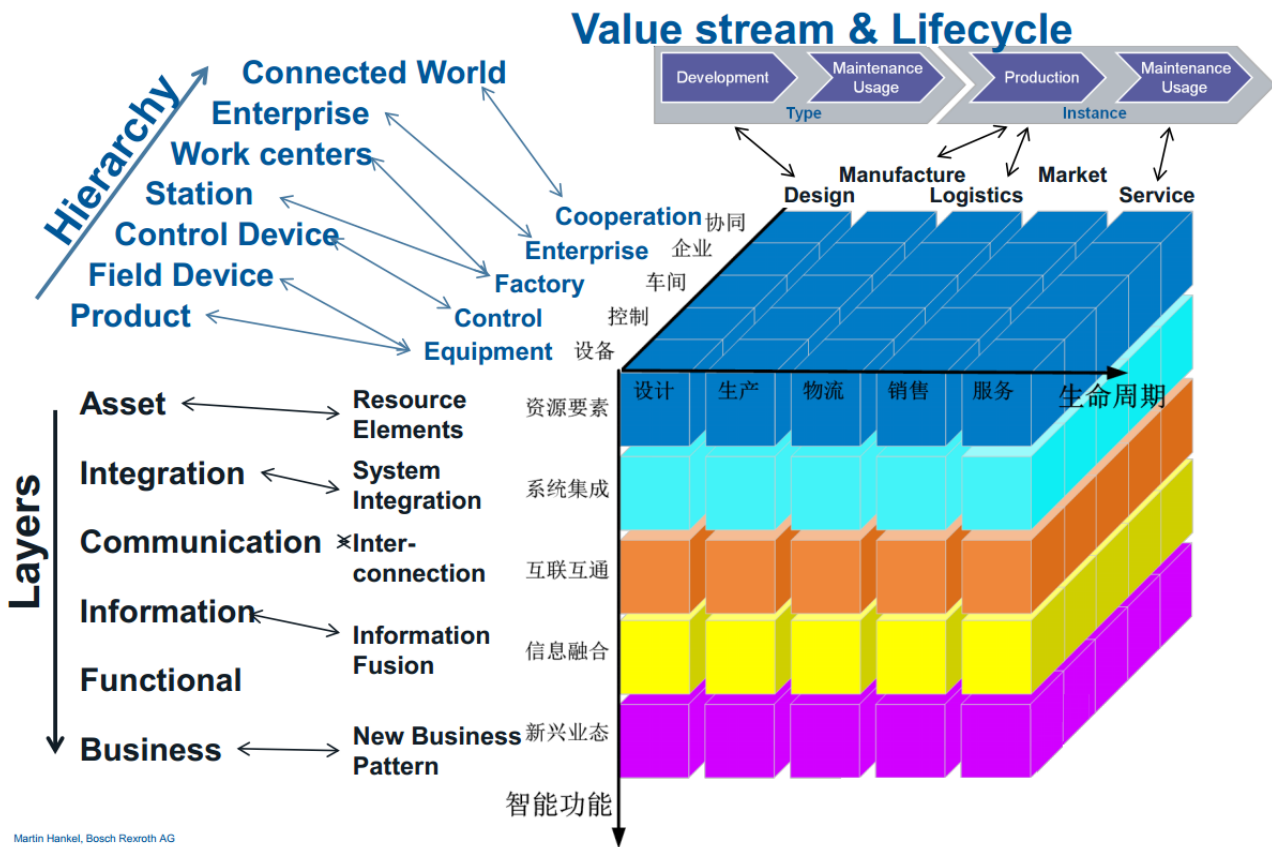

Martin Hankel, Bosch Rexroth AG

Fig 3. Element-to-element graphical representation of the similarities of IMSA v.1 and RAMI model

4. Aspect oriented conclusion finding for developing the models towards each other

Life-cycle axis

Both IMSA and RAMI share a common view on the importance and general structure of the life-cycle of factories, automation equipment and products within intelligent production. Both models adhere to a general, but powerful differentiation of the life-cycle in individual phases. For IMSA, this is: design, manufacture, logistics, market and service. For RAMI, this is mostly the same: development of type, usage of type (offering on the market), producing and distributing instances of these types and finally: facilitate production and supporting maintenance/ upgrade. This is in compliance with IEC 62890.

Therefore, nearly a 1:1 mapping already exists between the respective models. As a temporal parallel development, the discussions ongoing in ISO, IEC TC65 ad hoc working groups 3 and the preparation of the ISO/ IEC joint working group JWG 21 show, that strong, international interests exists to let the models recognize the individual requirements

of the life-cycle definitions of produced products, the production equipment and business operations of a factory.

Remark: all three individual life-cycles can be found in the RAMI model, as horizontal areas covering the elements of the product hierarchy level, the field-device to enterprise hierarchy level as also the layer of business procedures.

Proposed conclusion: Both countries should work on

- Dependable 1:1 mapping between the IMSA / RAMI life-cycle structure, including the possibility to find a new, general abstraction for the life-cycle elements, and
- Developing mappings to each of the life-cycle definitions of produced products, the production equipment and business operations of a factory in order to facilitate the international discussion.

Intelligent product

A small deviation can be found in the system hierarchy axis of both IMSA and RAMI models. As the most important aspect, both models feature a functional decomposition of business and production equipment into cooperation, enterprise, control and equipment elements. The RAMI element designations are chosen in accordance with IEC 62264

and IEC 61512 in order to reflect the particularities of both the factory and process automation.

In addition to that most important aspect, the RAMI model features two further elements within its system hierarchy: product and connected world. The product aspect is found to be important in order to reflect the necessities of the produced products within an own section of the model. This enables also the possibility, to have the produced products to be treated as assets, giving it the opportunity, to be described via standardized information elements, facilitate functions for manufacturing operations management (MOM) such as the ‚intelligent product‘ and to model business procedures in a well-identified layer within the model.

The connected world aspect is found to be important in order to maintain relationships along the supply chain (e.g. materials, half-products, products, assemblies) as well as the usage by the customer of the produced products, in order to facilitate continuous improvement of production. The connected world can be also seen as the connection between different ‚verticals‘ of the internet of things (IoT), which is important for discussion with such organizations like W3C and industrial internet consortium (IIC).

Proposed conclusion: Both countries should discuss including the product and connected world aspect into the system hierarchy of a joint model.

Remark: this discussion together with the discussion on the life-cycle could lead to the extension of both models to a 6 x 6 x 6 arrangement of elements.

Boundary between real world / virtual world and Integration Layer

One small difference to be found between IMSA and RAMI models was the treatment of boundary between real world and virtual world. For RAMI, the real world is only represented by the asset layer and the integration layer already serves in the virtual world for the adaption of real world features and states into the Industrie 4.0-compliant information world. For that reason, the integration layer supposedly holds many proprietary elements, while the information world represented by the information, function and business layers is in compliance with Industrie 4.0 Standardisation.

For IMSA, the system integration layer was discussed to care about many functions concerning about real world entities (aka assets). However, these can also be seen as part of the virtual world dealing with real world features.

Proposed conclusion: In order to strengthen similarities between both models, make examples and definitions for both models more concrete; supposedly saying, that the

layer of both models deal with the virtual world.

OPC-UA as 1st class communication standard in both models

Recently, the role of OPC UA within Industrie 4.0 was clarified further. For the life-cycle elements dealing with the instances and for the hierarchy levels up to work center level, OPC UA is defined as standard communication means. Further on, in the criterion for Industrie 4.0 compliant products developed by the ZVEI association, information is to be represented by an information meta model at least comparable or identical to the OPC UA information meta model.

In addition, the industrial internet consortium (IIC) agreed as well on OPC UA as the standard communication means for the smart production vertical.

For IMSA, means for scalable and interoperable communication is crucial for many intelligent functions as well.

Proposed conclusion: Both models point out OPC UA and its information meta-model as being standard for the relevant areas of model elements of instance / production / maintenance up to a hierarch level of the work centers / work shop.

Intelligent functions and functional layer

Both models adhere to the importance of functions and activities executed in each ‚column‘ of the respective model. Thus, these functions and activities need to be made possible for each element of the cross products of system hierarchy and life-cycle. The IMSA precisely layouts the different functions and activities, which need to be executed while the RAMI complements this viewpoint by proposing a layered approach for structuring the general problem into information, decentralized functions and procedures on the business layer. All these latter three entities should contain standardized elements, on which the driving/ accessing IT systems can rely on (thus become more powerful and easier to implement) and to foster interoperability. For the standardized access, means of standardized identification by a property repository are required.

Proposed conclusion: IMSA and RAMI should combine their views on intelligent functions and functional layer to

- a. jointly agree on a set of functions to be executed in each ‚column‘ of the respective model, and a
- b. Develop a joint approach on accessing standardized information, functions and business procedures by the means of an IT systems, such as stabilized APIs and an interoperable approach of property management.

Property management

The above described section relies on the existence and performance of a well identified property management. RAMI describes properties as standardized data elements with well-known individual attributes as being specified in IEC 61360 / ISO 13584. These properties can each be public or proprietary ones. The ability to hold both kinds in the same information management system is found to be crucial in order to facilitate an interoperable infrastructure but also allows addressing the unique selling propositions and individual strengths of the different vendors and competitors on the market. For this reason, RAMI foresees to rely on a set of multiple, strong property repositories such as IEC CDD, ISO or eCl@ss. This is in compliance with the Digital Factory (IEC 62832).

For the execution of intelligent functions within the IMSA, a similar approach could be established. The outcome of the impressive amount of Chinese Standardisation activities could be recognized and the individual elements of these Standardisation activities could be globally identified via a commonly agreed property management.

Proposed conclusion: In order to foster interoperability, both countries should

- a. Support each other in establishing one or more globally recognized property repositories, and
- b. Bring in the individual elements of Standardisation activities as individual properties (can be data or function elements).

Mapping of standards into both respective models

The RAMI and the IMSA model are both foreseeing the mapping of standards to the individual elements of the models. By this, indicative and required standards can be well identified for different the fields of applications. This is also a good means of marketing with the outside world in terms of dissemination and consultancy, giving clear indications to small or medium sized companies.

Proposed conclusion: With respect to mapping of standards, both countries should

- a. Continue to develop and disseminate mapping lists, and
- b. Synchronize these lists, in order to name the most identical standards on both sides. This synchronization should also identify gaps in Standardisation to be addressed by both countries.

Future work

In the aspect oriented conclusion finding, both partners agreed in the Qingdao meeting on finding a new, general abstraction for the life-cycle elements of both models. The target is to extend and synchronize the scope of both models.

Both partners can think of a dedicated conceptualization phase, were ideas for new products and sales opportunities are identified. This is clearly a distinct phase of the life-cycle model, as this occurs prior to defining product-lines and product types.

Both partners agreed on including logistics as an important part of manufacturing execution. This not only includes the pure transportation aspect of logistics, but also storage, as a time-consuming part of the life-cycle.

For increasing the sustainability of future models, both partners propose a distinct life-cycle phase, were not only end-of-line materials and waste management takes place, but an intensified push towards re-cycle and re-use scenarios is consequently promoted by engineering best practices and intelligent production functions.

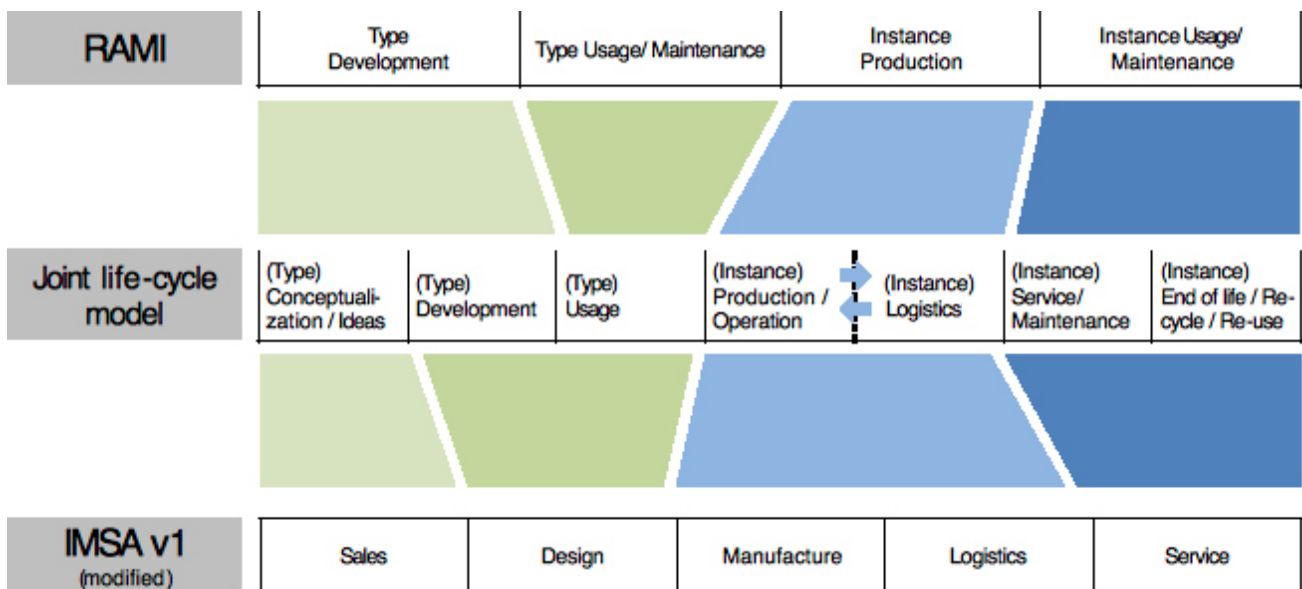

Fig 4. Proposed Joint Lifecycle Model

Appendix A: Applications verification for alignment

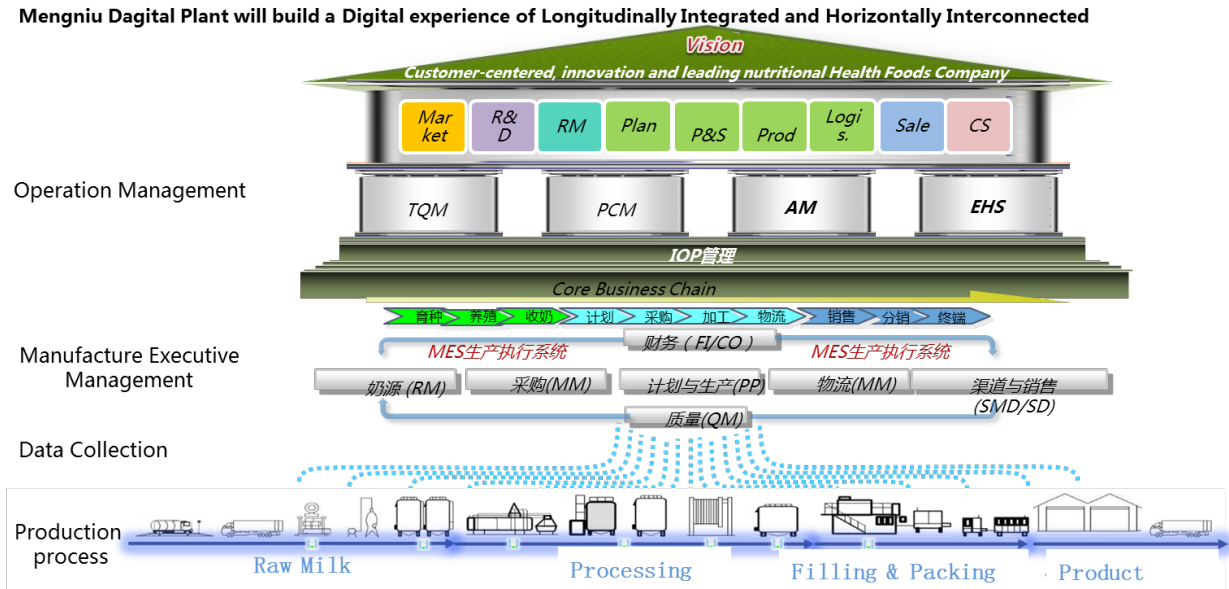

Fig.5 Integration of lean production and Intelligent Manufacturing

1. Application in Continuous Manufacturing

1.1 Introduction of Mengniu Intelligent Manufacturing Practice

1.1.1 Mengniu Intelligent Manufacturing Implementation Background

With arrival of the new dairy industry era, „Internet +“ and „China Manufacturing 2025“ are constantly pushing the development and revolution of enterprises. Product safety demands of customers become more stringent, R&D periods of products become shorter and the precision, flexibility, and intelligence of product and services raises new requirement for enterprises. Due to the fierce industry competition, cost management also results in tougher challenge for enterprises. By combining these problems with current lean production management of Mengniu, construction demand for the intelligent dairy plant came into reality.

1.1.2 Technology Roadmap and Target of Mengniu Intelligent Factory

Mengniu intelligent factory can be integrated into four levels: at the decision-making level, BI is applied to scientific

analysis and decision-making, at the management level, the ERP-SAP technology is used to manage the enterprise resources, at the executive level, the MES technology is used to realize digital management of production, quality, equipment, energy, logistics and so on, and at the control level, the robots, digital instruments, PLC, digital sensors and other technologies are used to achieve automatic production.



Fig. 6 Mengniu Intelligent Factory Layout

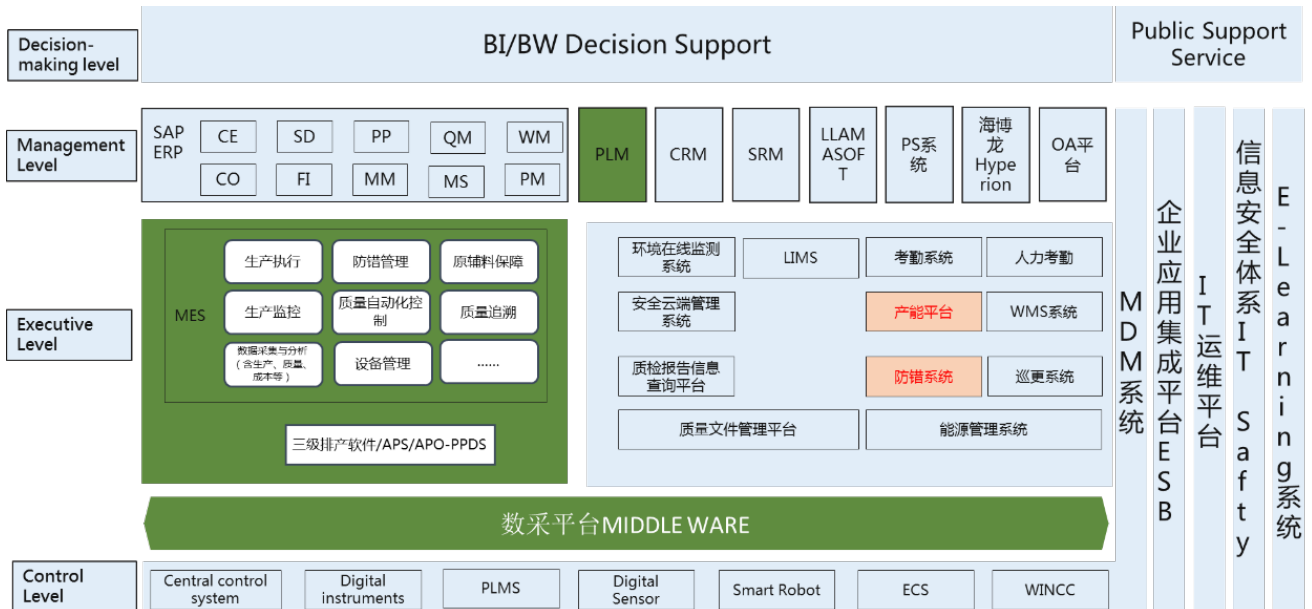

Fig. 7 Four Levels of Mengniu Intelligent Factory

In Mengniu intelligent factory, product orders are the core, and ERP is the mainline. The factory is integrated with PLM, MES, LIMS, EMS and WMS throughout the entire product life cycle. Furthermore, the problem of isolated information systems could be tackled. With big data, intelligent sensing, intelligent decision-making and accurate execution, all-around analysis and management of production process

can be realized in order to establish a concise and efficient intelligent factory. With transparent production, single-key traceability, and data based management, the factory can improve production efficiency and energy utilization, reduce operation costs, failure product rate, and shorten the product R&D cycle. Furthermore, the factory can improve the overall manufacturing level of the dairy industry and transform traditional dairy industry to an intelligent industry.

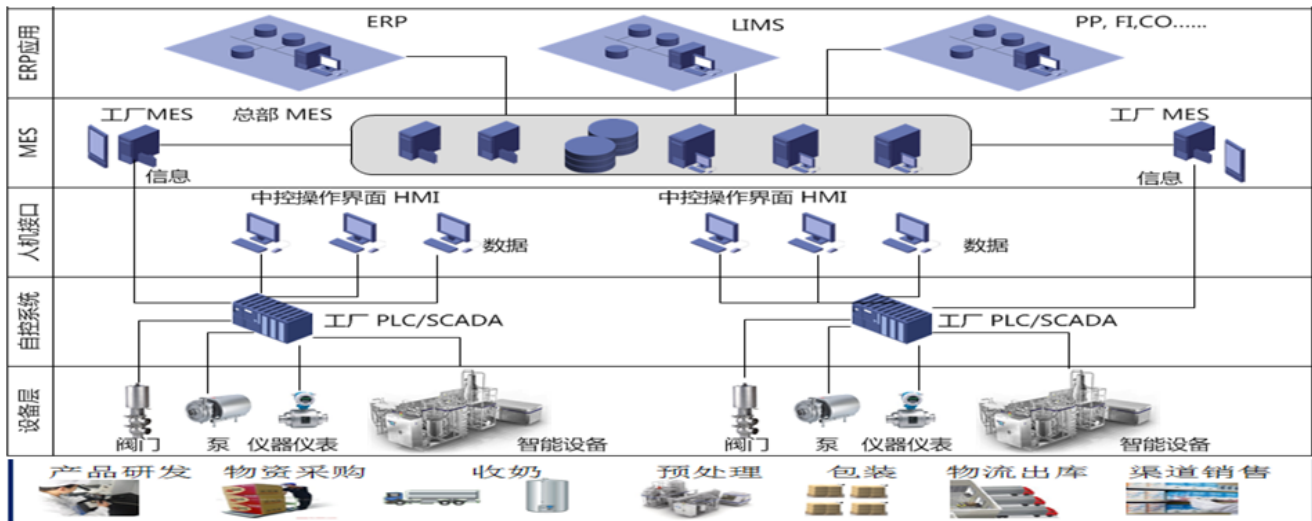

Fig. 8 Mengniu Intelligent Manufacturing 1

1.1.3 Mengniu Intelligent Manufacturing Experience Summary and Industry Standards Development

There are no matured standards to refer to, because intelligent manufacturing is a new concept in China and worldwide. Many enterprises carry out intelligent manufacturing system differently, which results in duplicated construction and incompatibility in the systems. It is necessary to develop standards to standardize and regulate the intelligent manufacturing systems in the dairy industry. By cooperating with CESI, Mengniu refines the high-quality intelligent manufacturing practices and formulates three intelligent manufacturing standards as the dairy industry reference:

a. Technology Requirement for Intelligent Energy Management and Control System

Its contents include equipping rate and performance requirements of metrology instrument. For example, these instruments need to have the functions of data collection, data memory, and data remote transmission. The standard further includes aspects of data acquisition correctness, real-time correctness for remote control; and management requirements for safety cloud technology.

b. Intelligent Dairy Factory Workshop Operation Management Requirements

According to characteristics of intelligent dairy factory/workshop, network and communication should be unblocked. The data collected by SCADA in the production process should be interlinked with the production order data from MES, so that the factory/workshop data can be tracked on demand. At the same time, the MES data can interact with the ERP data. In order to provide more accurate decision, a report analysis based on BI can be implemented.

c. Specification for Dairy Laboratory Informationalization

The laboratory management system of CNAS17025 can be applied to laboratory information management. The connection of inspection instruments, the automatic upload of inspection, the digitalization of original records, the generation of automatic inspection report, the configuration of real-time inspection methods, the execution of an automatic quality control plan, and others can be specified in the factory. Technology standard for laboratory setup, application and management can be developed, so as to solve lack of laboratory information and automation standards, improve the intelligence level of laboratory inspection control, and guide automation and information of inspection laboratories in various industries.

1.2 Position of Mengniu Intelligent Factory in RAMI 4.0 Model

The Mengniu intelligent factory is an innovative integration and application of the whole enterprise system process, and has a high consistency with the RAMI 4.0 model. In the function dimension, Mengniu intelligent factory covers assets, integration, communication, information and function. The cloud platform of Mengniu intelligent factory is constructed, and the information fusion and intercommunication of the entire process are realized. In the enterprise architecture level dimension, the factory realizes the interconnection of people, equipment and system, and achieves production status awareness, real-time analysis, autonomous decision-making and execute accurately. In the dimension of life cycle and value chain, Mengniu's intelligent factory integrates and connects PLM, MES, LIMS, EMS, WMS and other systems. Furthermore, interaction of design, production, traceability, energy management and logistics management, transparent production, one-key traceability and data management are achieved.

1.3 Position of Mengniu Intelligent Factory in China IMSA

As a complete process-oriented industry, Mengniu intelligent factory with strong production continuity and fixed process fully meets all the characteristics of process-oriented manufacturing, such as milk collecting, milk cleaning, milk transferring, pasteurization, mixing, volume confirming, UHT, filling, packaging, warehousing. In Mengniu's intelligent factory, the system would analyze, convert and automatically arrange product orders. By integration and interaction of the subsystems, materials, raw milk, quality inspection plan, energy, storage location can be provided according to the demand. Production task information can be tracked in real time and energy consumption can be monitored at the same time. Therefore, the factory can achieve more efficient production, more reliable process, more visible cost control and more convenient management.

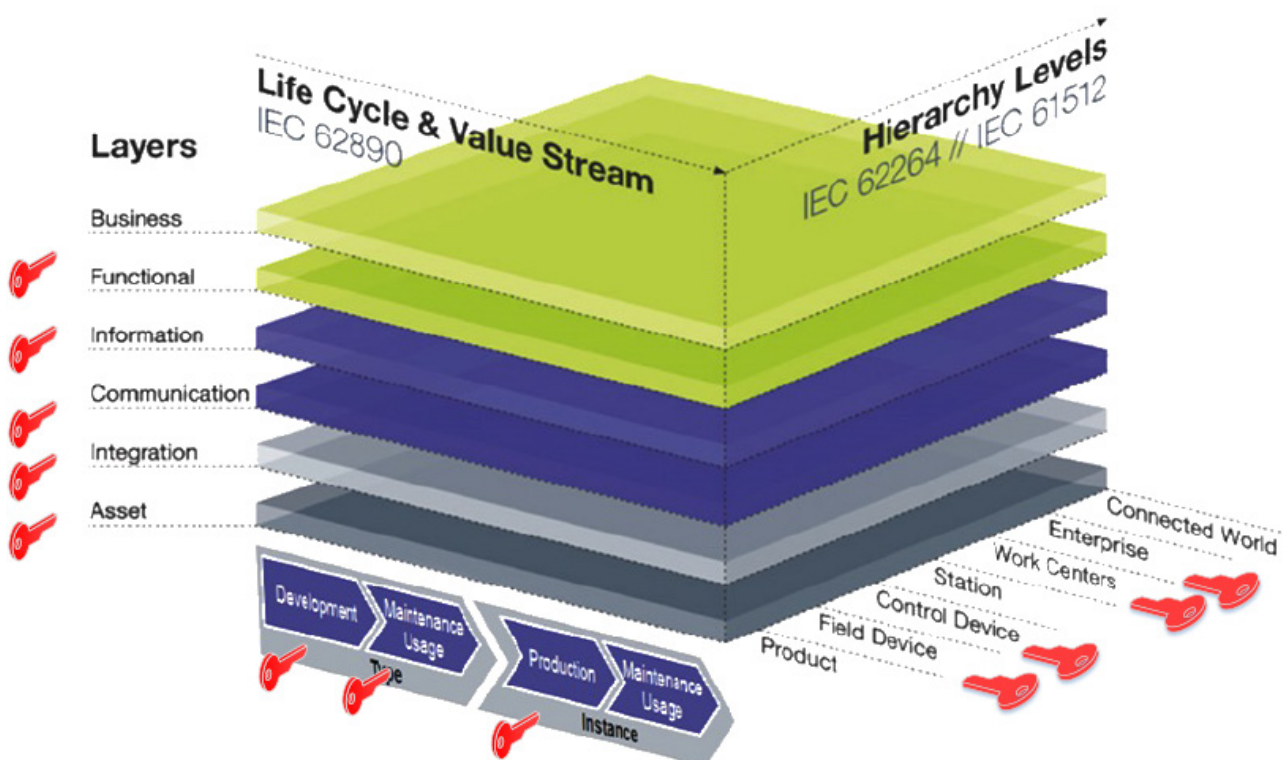

Fig. 9 Mengniu Intelligent Manufacturing's position in RAMI 4.0 Model

Mengniu’s intelligent factory almost covers all aspects of IMSA. In the life cycle dimension, Mengniu intelligent factory covers design, production, logistics and other aspects, with integration and connection of PLM, MES, LIMS, EMS, WMS and other systems. In order to achieve transparent production, one-button traceability, and data management, the whole process intercommunication of product design, production, traceability, energy management, logistics management is realized. In the system level dimension, Mengniu intelligent factory covers equipment, control, workshop, enterprise and other aspects, and achieves the interconnection of people, equipment, and system. As a result, status sensing, real-time analysis, automatic decision-making and accurate execution are realized. In the intelligent function dimension, Mengniu’s intelligent factory covers resource elements, system integration, interconnection, information fusion, and builds the cloud platform to realize the information fusion and interconnection of the whole process.

1.4 Conclusion

Based on the comparative analysis between Mengniu intelligent factory and RAMI 4.0 model and IMSA, the two models have very high consistency in the aspects of the system level and the hierarchy level, or the intelligent function level and the layers. On “Value stream & Life Cycle” dimension, the RAMI4.0 model defines the Type and the Instance. The life cycle axis is divided into 5 dimensions in IMSA. In Mengniu’s intelligent factory, it includes the design, production and logistics of the life cycle axis. These are coordinated with the development, maintenance usage and production of the “Value stream & Life Cycle” dimension in the RAMI 4.0 model. Thus, we can derive a conclusion that the IMSA and RAMI 4.0 model can be mutually recognized.

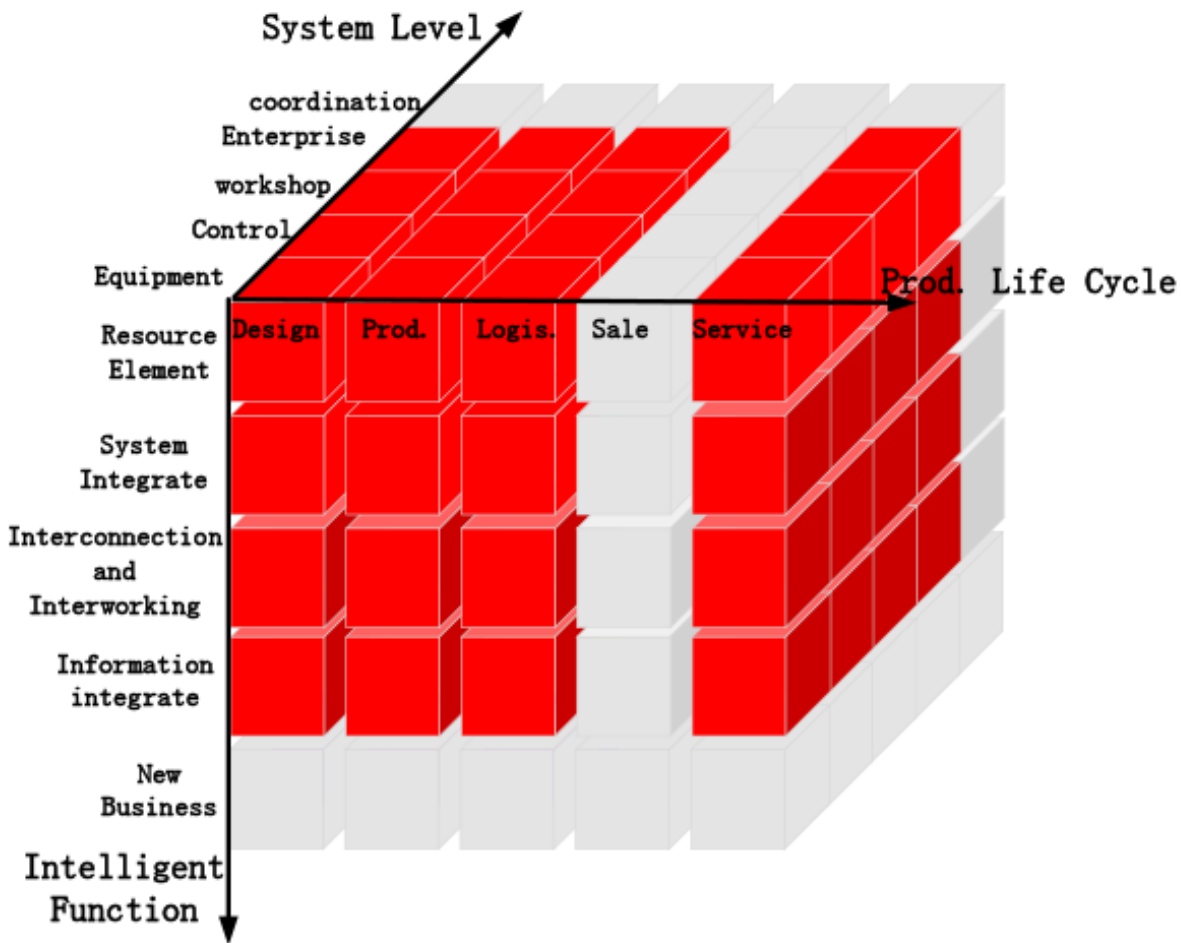

Fig. 10 Position of Mengniu Intelligent Factory in IMSA

2. Application in Discrete Manufacturing

2.1 Smart Engineering and Production 4.0

Smart Engineering and Production 4.0 (SEAP) is a cooperative research project of the companies Eplan Software and Service, Rittal and Phoenix Contact in the fields of continuous engineering and intelligent production in the context of Industrie 4.0. The project focusses on the engineering of cabinets and the automated assembly of these cabinets.

The three companies have distinguished and overlapping roles in the research project. Eplan Software and Service is a vendor for engineering software (electrical and mechanical engineering). Rittal is a vendor for enclosures and climate-control technology, but also for machines for enclosure treatment and automated cabinet assembly. Phoenix Contact is a manufacturer of components and electronic devices for (among others) cabinets and also a vendor of machines for automated cabinet assembly.

The project investigates how article information can be imported into different engineering tools and how configuration tools for articles can be fluently integrated into the engineering process. Furthermore the exchange of information between engineering tools is considered to create one consolidated virtual prototype (digital product description) as the result of the engineering process. Finally, it is considered to use the virtual prototype for the steering of the production process on different machines. This corresponds to the use case “Order-Controlled Production” (OCP) of the Plattform Industrie 4.0.

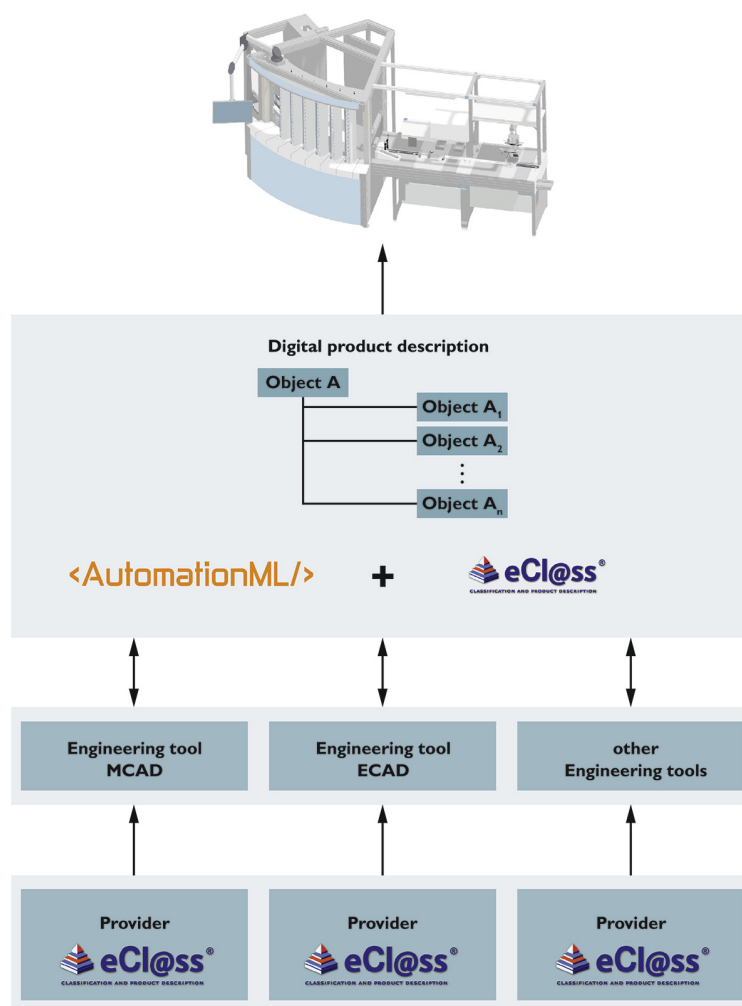
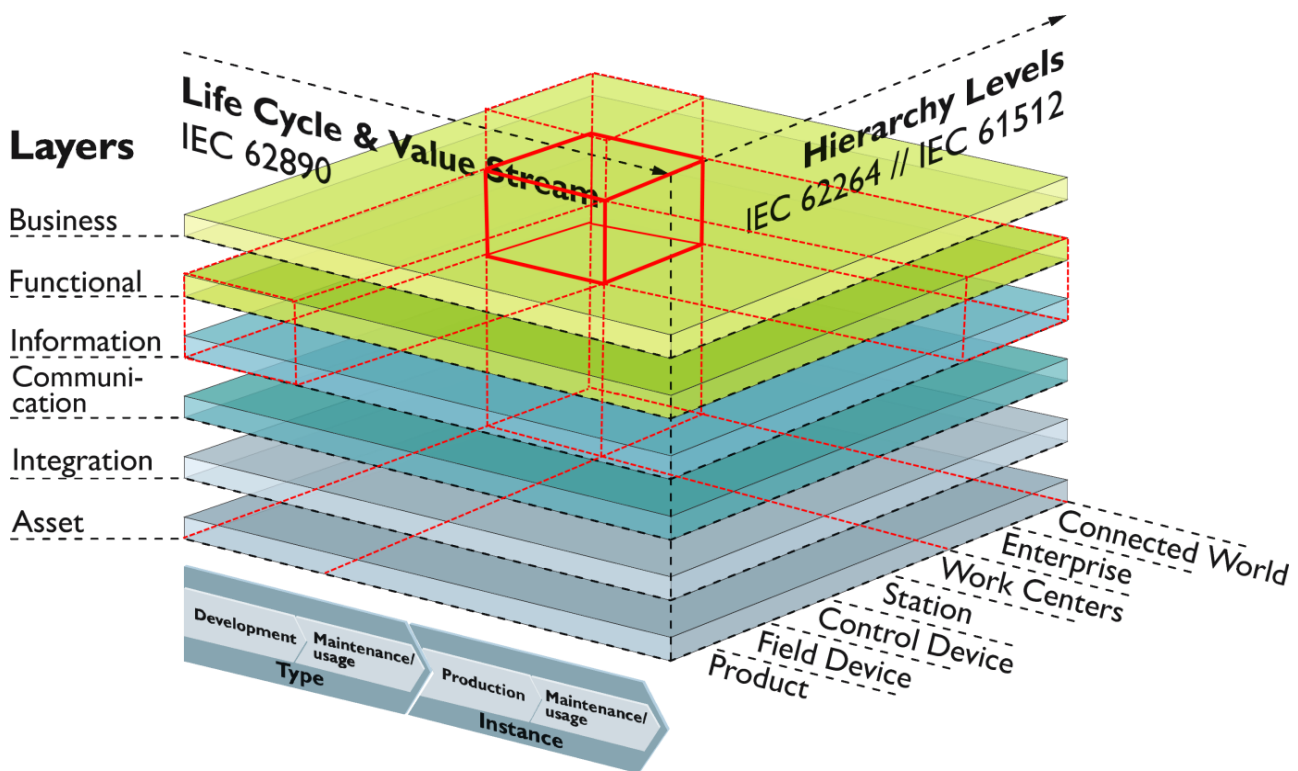

Fig.11 Import of article information (eCl@ss) into engineering tools. The result of the engineering is stored in the virtual prototype (digital product description) and used for the steering of the production

2.2 Application example: Import of digital models into the engineering

Engineering-tools provide the possibility to import digital models of articles, so that these articles can be used in the engineering. Unfortunately, there is presently no standardized import data format for that purpose. This is a drawback for component vendors, because the vendors have to support several data formats, possibly in different versions – what results in a big effort to maintain their different PLM/PDM export interfaces. The SEAP project investigates, how this drawback can be resolved with existing description data formats, like for example AutomationML or eCl@ss/BMEcat.

In the RAMI4.0 this activity can be assigned to the functional and information layers, the development phase on the value stream (or life cycle) axis and the enterprise and connected world hierarchy levels. The import function of the engineering tool is located in the functional layer, while the digital models of articles are located in the information layer. Therefore both layers are involved. The engineering tools are used in enterprises, while the digital models are received from the connected world, for example as a download. The engineering of a cabinet is part of the development phase on the value stream axis. It is arguable, that regarding the digital models also the maintenance/usage part of the value stream axis is involved.



Quelle: Plattform Industrie 4.0

Fig. 12 Import of digital models into the engineering

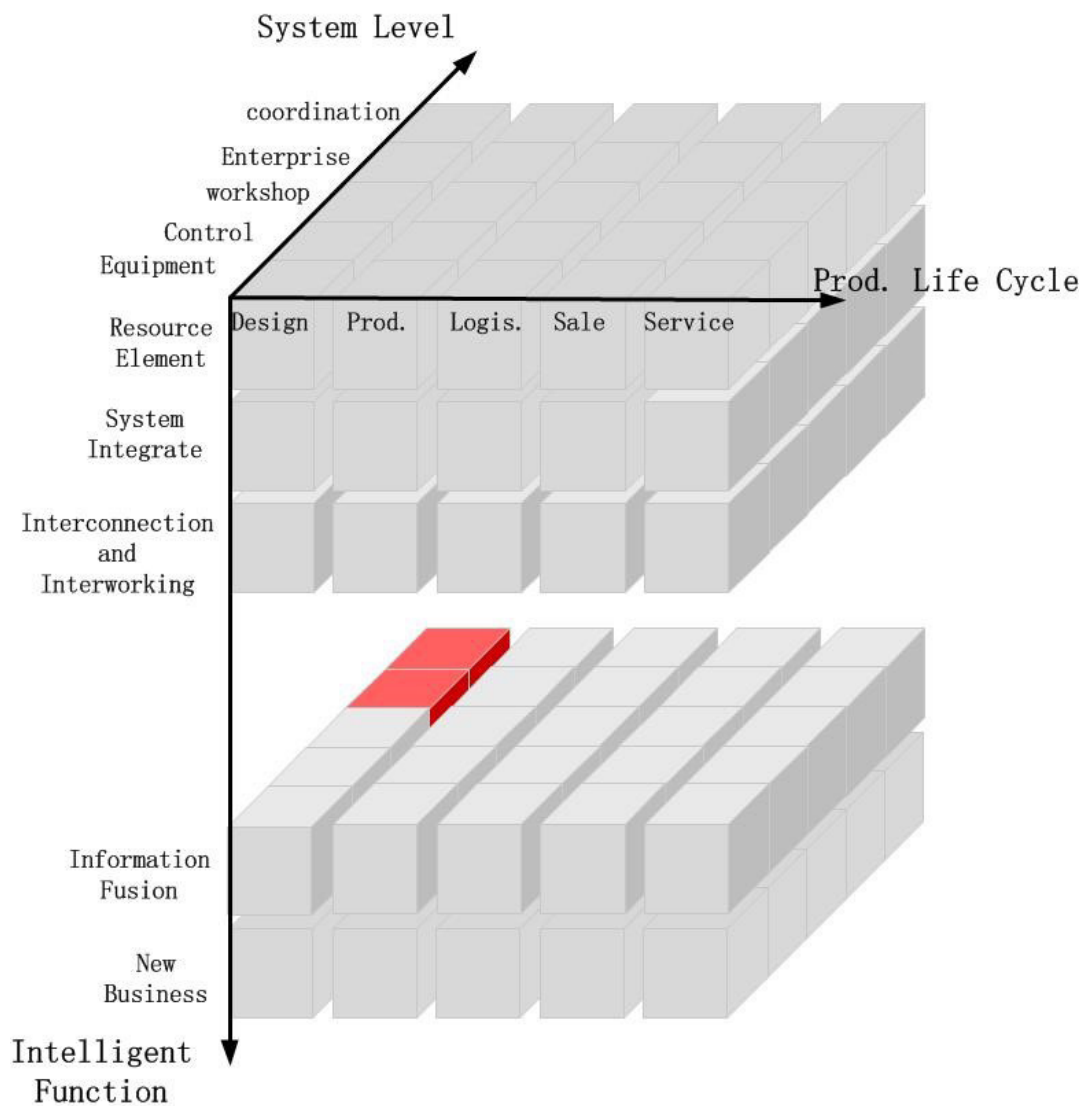

Fig. 13 Mapping to the Chinese Intelligent Manufacturing System Architecture

2.3 Application example: Integration of product configurators into the engineering

Furthermore, the integration of product configurators into engineering tools is considered. Comparable to the first application example, it is unfavorable for component vendors to develop different product configurators specifically for different engineering tool. It is also important for the product configurator to have a direct access to the IT system of the vendor to receive product information and to generate lot size one enabling order numbers. Therefore a mechanism is needed to enable engineering tools to request available or applicable product configurators from the vendors. These product configurators are located in the IT systems of the vendors (for the information access), but for the customer user experience the configurators seems to be plugged into the engineering tool. At the end of the configuration process, the generated order number and a digital model of

the configured product has to be transferred into the parts management system of the engineering tools, so that the configured product can directly be used in the engineering process (compare: Application example: Import of digital models into the engineering) and ordered.

As well as in the first application example, this activity can be assigned to the functional and information layers, the development phase in the value stream (or life cycle) axis and the enterprise and connected world hierarchy levels. The integration of product configurators and the import function of configured products into the engineering tools are located in the functional layer, while the digital information for the product configurator and the models of the configured products are both located in the information layer. Hence, both layers are involved. The engineering tools are used in the enterprises, while the configurators and the digital models of the products are received from the connected world. The hierarchy level connected world is involved, because the product configurators and the product information data bases are located in the IT systems of the vendors. The engineering of a cabinet is part of the development phase on the value stream axis.

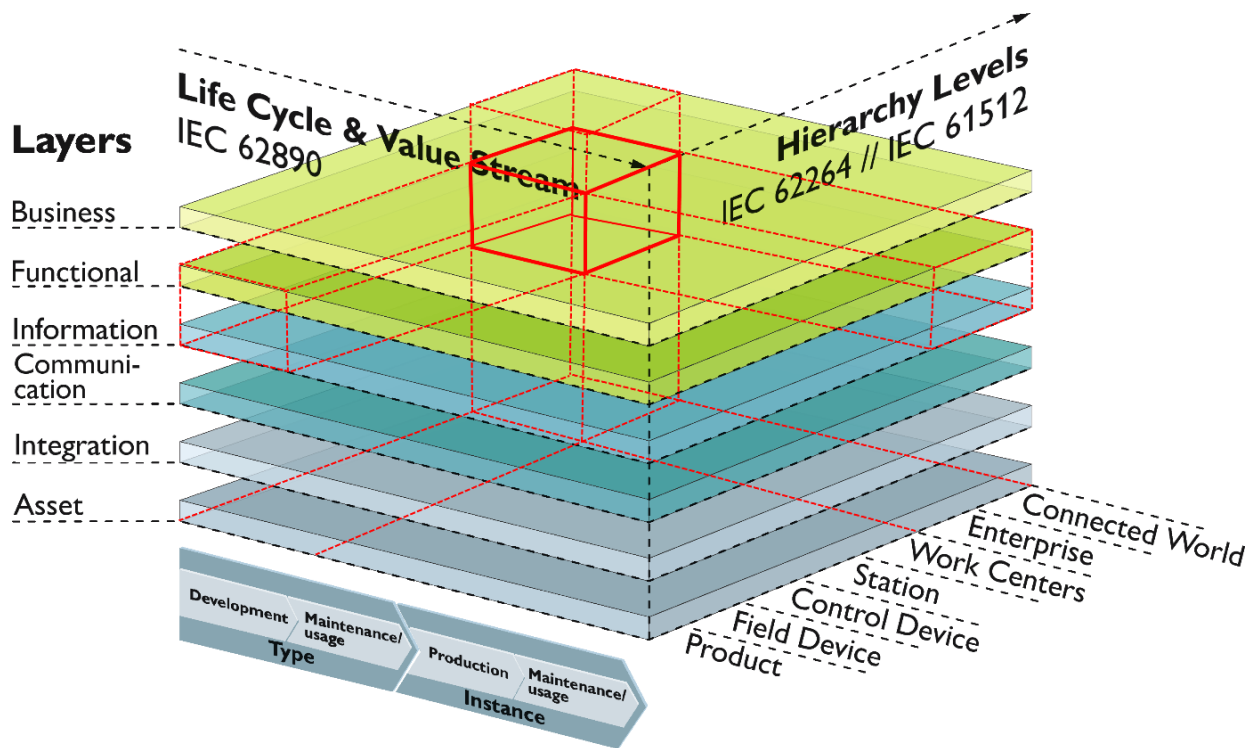

Quelle: Plattform Industrie 4.0

Fig. 14 Usage of product configurators and import of digital models in engineering tools

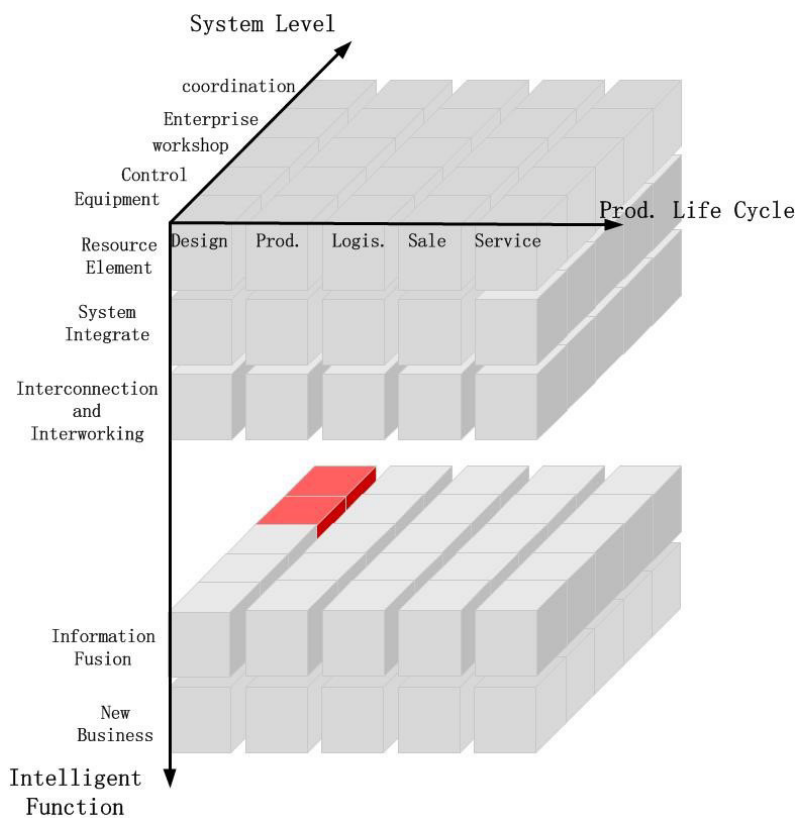

Fig. 15 Mapping to the Chinese Intelligent Manufacturing System Architecture

2.4 Application example: Order-Controlled Production

In the SEAP project, the result of the engineering process is called the virtual prototype. This prototype consists of a digital description, using AutomationML and eCl@ss Advanced. The digital description – the virtual prototype – is part of the Asset Administration Shell (AAS) of the product and is one proposal for a possible implementation of the so called submodels of an AAS. The virtual prototype is designed to enable intelligent machines to analyze it. The AutomationML part describes the relations of the used components, the eCl@ss Advanced part describes the classification and the typical and comparable attributes of the components. For example, the AutomationML part describes, that components of the eCl@ss class 27-14-11-20 are mounted on a component of class 27-40-06-02 and also the single spatial positions are described. The eCl@ss classification defines, that the class 27-14-11-20 is a terminal, and that such a terminal has a color, a length, a width, a number of connection points and so on. Class 27-40-06-02 is a DIN rail.

In the project, the analysis of the virtual prototype is then done by a simple rule-based reasoning. “If a terminal (27-14-11-20) is mounted on a DIN Rail (27-40-06-02)” □ Production step “terminal mounting” is needed.

Based on such rules, a list of necessary production steps for the virtual prototype is created. The next step is that an Industrie 4.0 service provider starts to negotiate some kind of a digital production contract with the machines connected to the service provider. The negotiations can include:

- Which machine offers which production steps? (mandatory)
- When can the execution of the production step(s) be scheduled?
- What are the costs of the execution of the production steps?

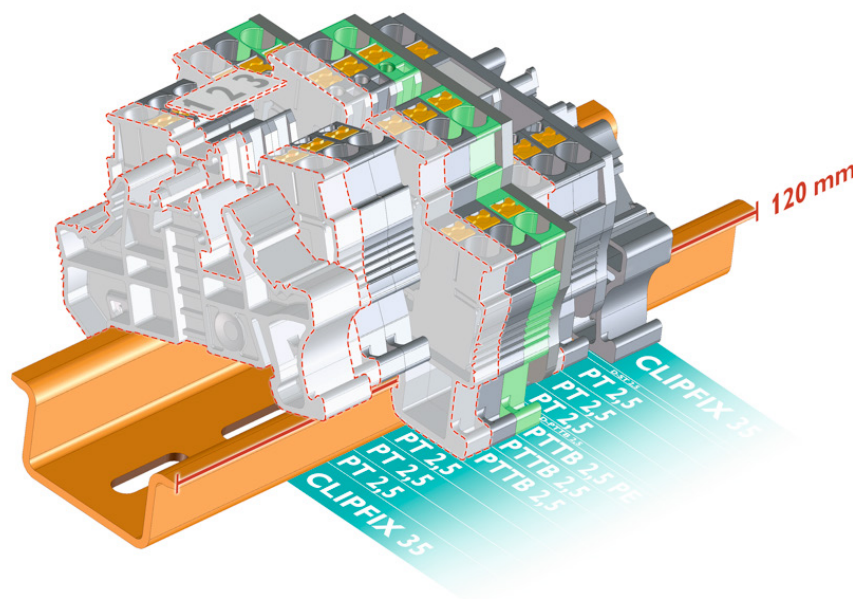

Fig. 16 Terminals mounted on a DIN rail

The result of the negotiation is a dynamically generated production plan (or digital contract) with declarations about time and money.

At the beginning of the production, the virtual prototype (AutomationML and eCl@ss Advanced) together with the negotiated productions steps is transferred to machines. The machines read in from the virtual prototype the data needed for the production steps and execute these steps.

In the RAMI, the application example Order-Controlled Production is located in the layers functional, information, communication, integration and asset. If external production facilities are connected to the service provider, also the business layer would be involved. On the life cycle & value stream axis the region from type-usage to instance-production is used and the hierarchy levels are from enterprise to work centers. Here again, also the connected world would be involved, if external production facilities are connected to the abovementioned Industrie 4.0 service provider. In the functional and the communication layers is the negotiation with the machines located, the integration and the asset layers are responsible for the production and partly also already during the negotiations.

On the life cycle and value stream axis the usage of the type (virtual prototype) is used for the negotiations and as template or construction plan for the work units. With the start of production, for every produced article an instance of the type is created, additionally containing information about its physical twin (for example production date and time). Assuming that the Order-Controlled Production is applied on the shop floor of a company, only the hierarchy levels enterprise and work centers are involved. The hierarchy levels station and lower would be relevant, if the production steps on the machines would be investigated in detail.

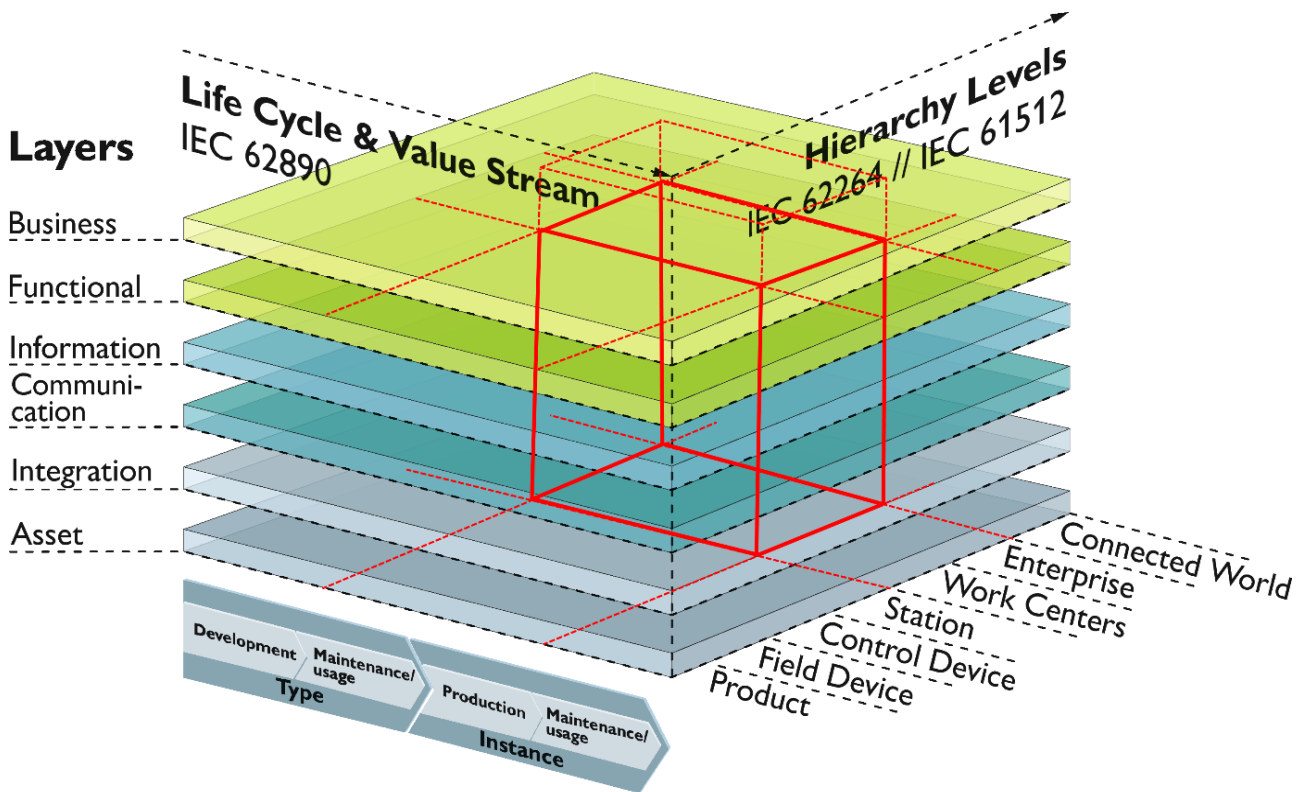

Fig. 17 Order-Controlled Production in RAMI 4.0

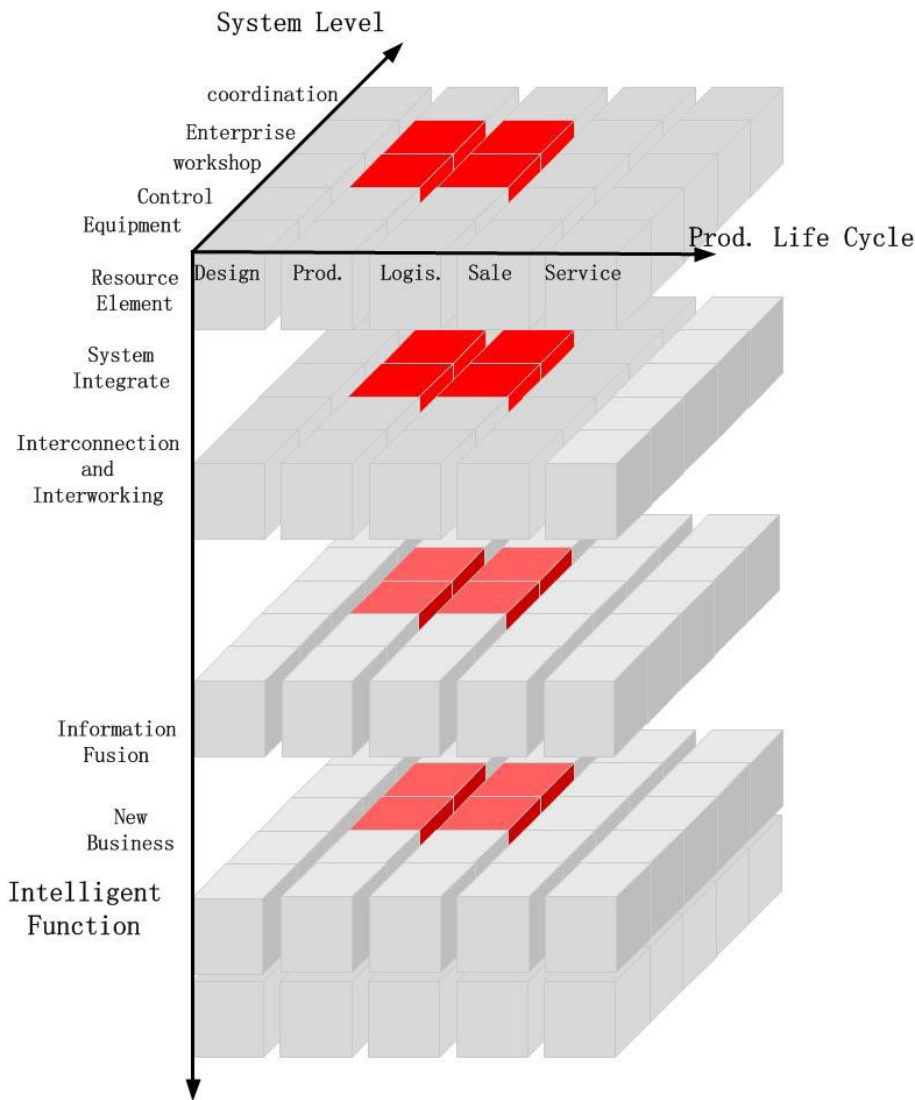

Fig. 18 Mapping to the Chinese Intelligent Manufacturing System Architecture

2.5 Summary/Conclusion

In this document three application examples based on the project Smart Engineering and Production 4.0 have been briefly introduced. The application examples also have been depicted in the Reference Architecture Model Industrie 4.0. The model helps to identify the involved layers, the involved area of the life cycle and the involved hierarchy levels. These identifications can help to define the fields of activity in an Industrie 4.0 project. The identification can also help to design an architecture for an Industrie 4.0 applica-

tion with exchangeable and reusable layer implementations for the different hierarchy levels. Furthermore the Reference Architecture Model Industrie 4.0 facilitates the probability of interoperability of different Industrie 4.0 components, because the layers and hierarchy levels can be interpreted as a separation of concerns – and it can be expected, that the interaction pattern of the layers will be well defined.

3. Application in Hybrid Manufacturing

In order to promote the practical cooperation between China and Germany in the field of intelligent manufacturing, the Ministry of Industry and Information Technology of the People’s Republic of China launched the pilot demonstration project of Sino-German intelligent manufacturing cooperation in September 2016. A total of 14 projects were selected, in which the China Baosteel Group Co., Ltd. and the German Siemens Co. developed “Jointly-Exploring in Steel Industry of Baosteel and Siemens” pilot demonstration project of Industrie 4.0. The project is a typical application for Sino-German Intelligent Manufacturing/ Industrie 4.0.

3.1 Background Info of Baowu and SIEMENS Go to Industry 4.0 (BSG2I4.0) Project

The project was launched in 2015 when the former Baosteel Group announced its blueprint for intelligent manufacturing in iron and steel production. The key objectives of the project were to create greater plant and process visibility through a higher level of automation, integrate and connect the various production systems, implement an infrastructure for obtaining real-time information and production performance, and ensure data consistency and accessibility along the entire value chain. All this would help Baowu improve production efficiency, increase production flexibility, and make better and more sustainable use of resources.

3.1.1 Strategic cooperation

In collaboration with Siemens, Baowu is focusing on enhancing energy efficiency, improving quality, and achieving greater productivity. The two companies have formed a strategic partnership to jointly develop suitable systems and technologies required for creating a digital steel plant, and upgrading processes and equipment for automated operation. This collaboration is widely recognized as a best practice model combining Germany’s Industrie 4.0 strategy with the „China Manufacturing 2025“, and is a benchmark in intelligent manufacturing in China’s iron and steel industry.

Siemens has deployed a team of dedicated specialists to work with Baowu experts and has already developed more than 15 pilot projects meeting the criteria of innovation, repeatability, and profitability. These include projects on smart energy, multiple wireless applications, RFID identification for roll-oiling robots, and an application for frame truck tracking in the finished products warehouse. The two companies are also working on a pilot project for a digital twin and for digital operations in metals: the “Intelligent 1580 Hot Strip Mill.”

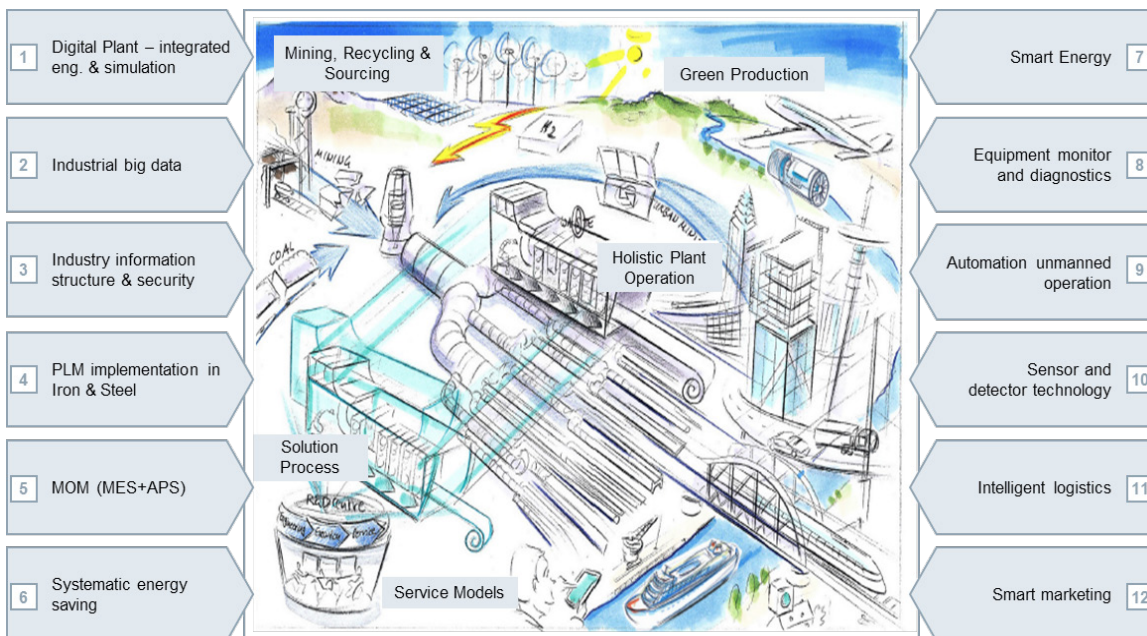

Fig.19 Cooperation Projects of Baowu and SIEMENS

3.1.2 A pilot for smarter steel

In these projects, Baowu and Siemens collaborate in many fields of technology, including visualization, digitalization and simulation, reducing energy consumption at the workshop level, equipment monitoring and diagnostics, sensor and detector technology, intelligent manufacturing operations management, big data in industry, industry information structure, and security. The goals for the project makes for quite a list: Setting up a company-wide production planning and scheduling system to improve capacity balancing, establishing one platform for real-time data transparency on key KPIs, setting up a common data backbone and virtual manufacturing, implementing systems for virtual reality operator and maintenance training, implementing a secure network for retrieving, storing, and aggregating production data, deploying systems for energy monitoring and optimization at the workshop and equipment level, as well as developing a range of new solutions for process analysis and asset management.

Only a year into the project and despite the numerous areas it covers, the progress has been impressive. The joint project

team is already working on the first concrete feasibility studies for the seven topics selected for implementation. In the long-term, Baowu wants to tackle the issues associated with full value chain integration, including integrating product development and design with production and logistics. Siemens is contributing its vast industry expertise to this project as well, and can rely on a broad base of systems and solutions for equipment and product lifecycle management, such as the COMOS engineering design platform and the Teamcenter collaboration platform. At the same time, both parties will continue to promote intelligent manufacturing at Baowu production facilities in Shanghai, Zhanjiang, Wuhan, and Meishan through several collaborations, including the strengthening of talent development for intelligent manufacturing. With this collaboration, Baowu and Siemens will make an important contribution to developing an Industry 4.0 standard for China's iron and steel industry as well as exploring innovative and sustainable business models for other industries.

3.2 Case Study

As BSG2I4.0 project was assigned by MIIT as best practice for China’s intelligent manufacturing standard. Corresponding to RAM I4.0 model, the practices of BSG2I4.0 project would be the right case to do the mutual recognition test and analysis.

There will be 3 cases analyzed in this section by positioning the case in the RAMI4.0 model and the IMSA to test whether the two models can be mapped.

3.2.1 Non-Contact Radar Detector Sensor Development

The project is to develop a non-contact thickness measurement of nonmetal material, which can be used to replace

manual measurement, by the innovation technology of “Vayyar frequency modulated radar”. The system architecture of the sensor is as follows.

As this project is a development of a new sensor, on the “Hierarchy” axis, it belongs to the Field Device level. On the “Layer” axis, the project belongs to asset level. And for the “Life Cycle & Value Stream” axis, this project is obviously the development of a new type of sensor, we can put it on the “Type” level.

For the reference model of IMSA, we can also do the positioning for this project. From the aspect of “System Level”, the project belongs to “Equipment” level and from the aspect of “Intelligent Functions”, the project belongs to “Resource Element” level. For the aspect of “Life Cycle”, it obviously a new type of sensor development, belongs to “Type”.

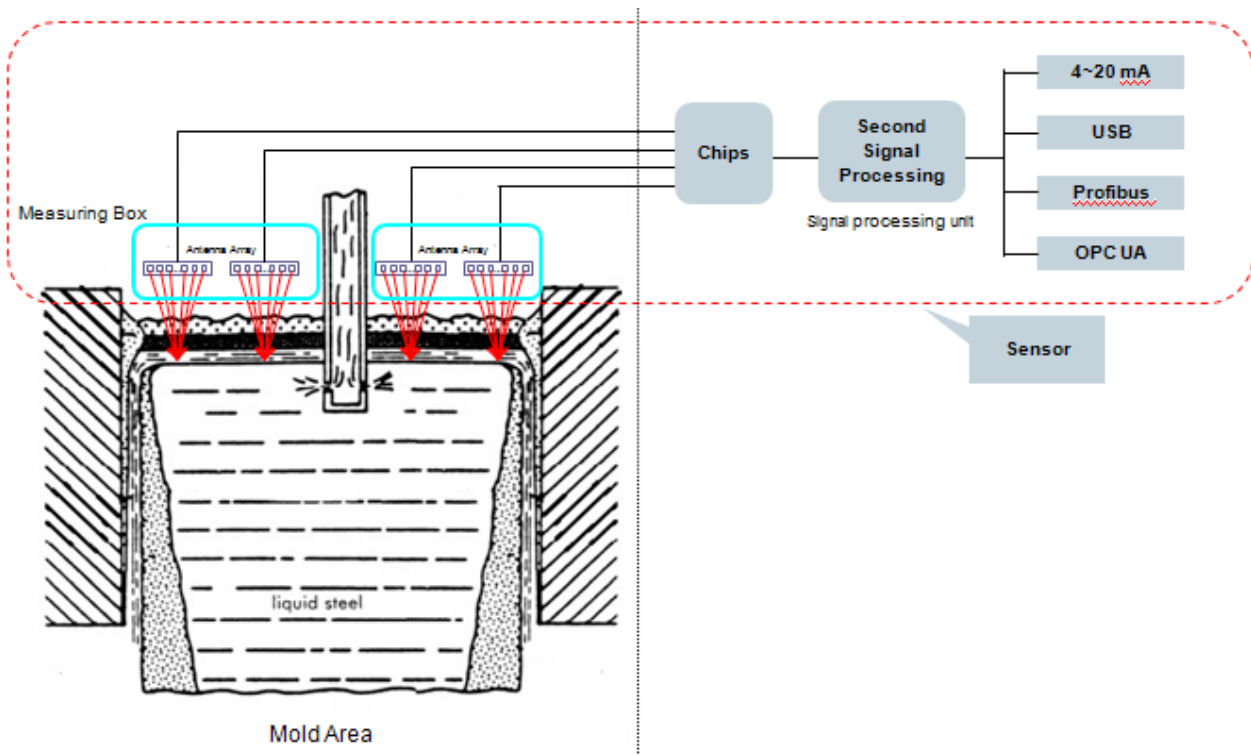

Fig.20 System Architecture of the Sensor

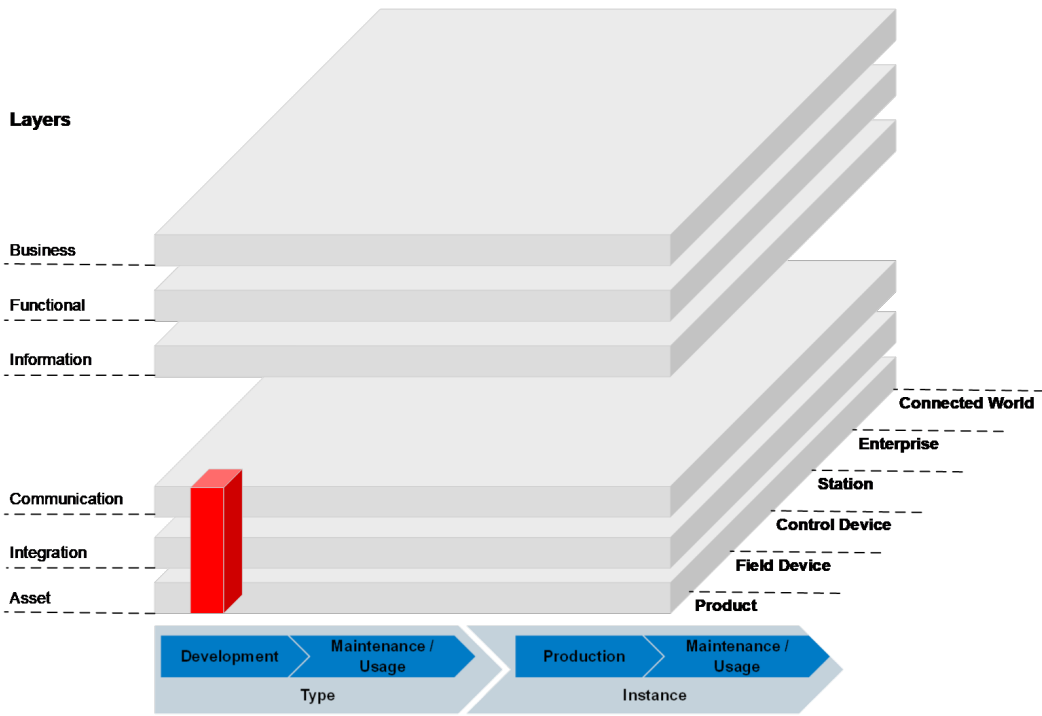

Fig.21 Position of the Sensor Development Project in RAMI 4.0 Model

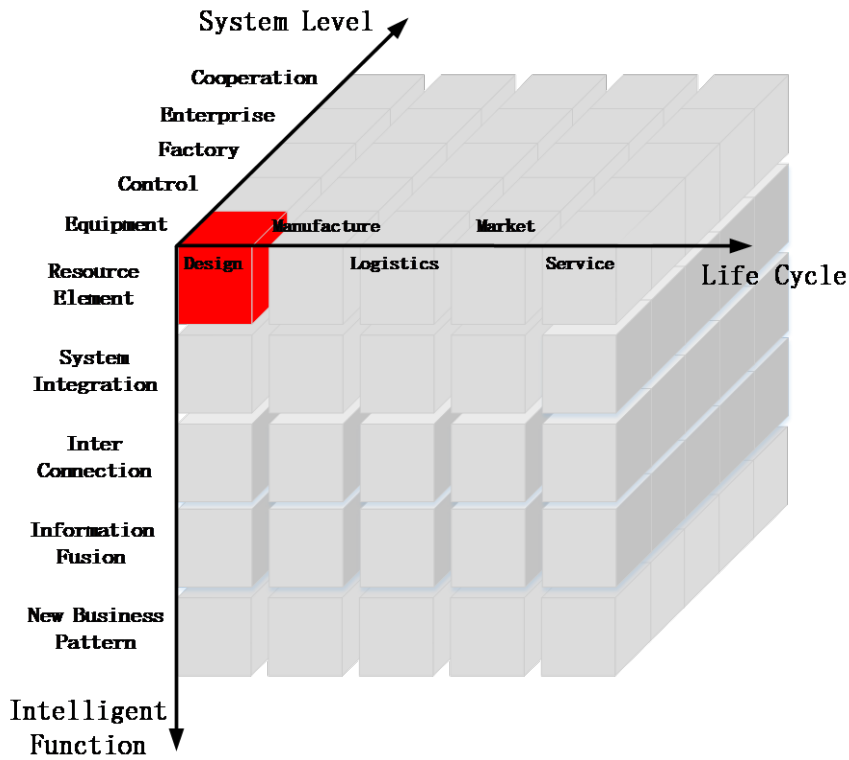

Fig.22 Position of the Sensor Development Project in IMSA

3.2.2 Smart Energy Project

In recent years, saving energy is an important aspect of the work at Baosteel. The energy consumption of per ton steel has been in the industry leading position. From the device point of view, Baosteel’s previous work mainly focused on replacing old motors with high efficiency models, under S7 energy-intensive transformer elimination, installed energy saving lamps and the fan, pump retrofitted by converter etc. All the new project use high efficiency and energy saving components. From the perspective of production line, except in cases were energy saving components realized energy savings within a single unit, usually the energy consumption of the production line is still depending on the original design program.

This project was set up for the energy saving of the cooling systems of the main mill of 1580 hot strip mill. The cooling

air supply of this unit was designed for the max productivity, and the cooling fans were working on power frequency all the time. This meant that there was more cooling air supplied than necessary. Baosteel needed a solution to supply the cooling air to the main mill according to the demands of the process. At the same time, they requested this solution can be integrated to their existing energy management platform and equipment diagnostics platform. Our solution is as follows.

When we positioning this solution in RAMI4.0 model, we can see on the “Hierarchy” axis, the solution can cover from Field Device dimension to Station dimension. On the “Layer” axis, the solution can cover from asset dimension to functional dimension. On the “Life Cycle” axis, the energy saving solution is an important link of the production chain, so it’s part of the instance of production.

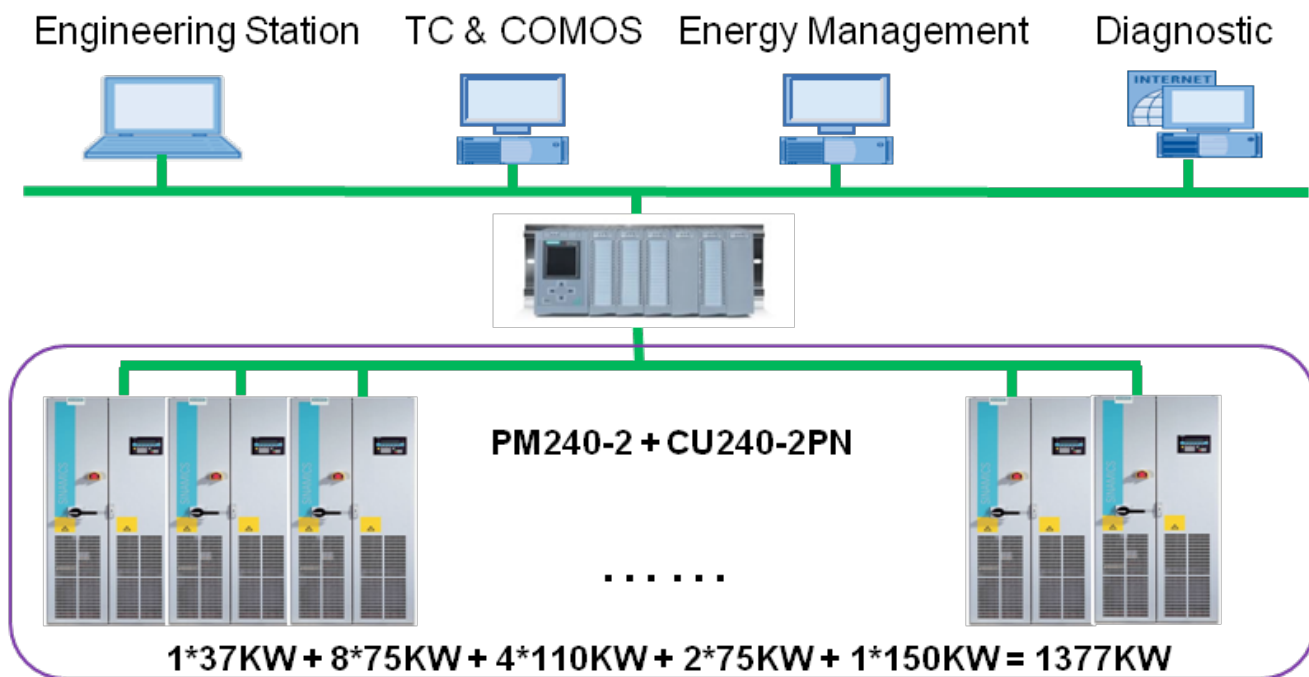

Fig.23 System Architecture of the Solution

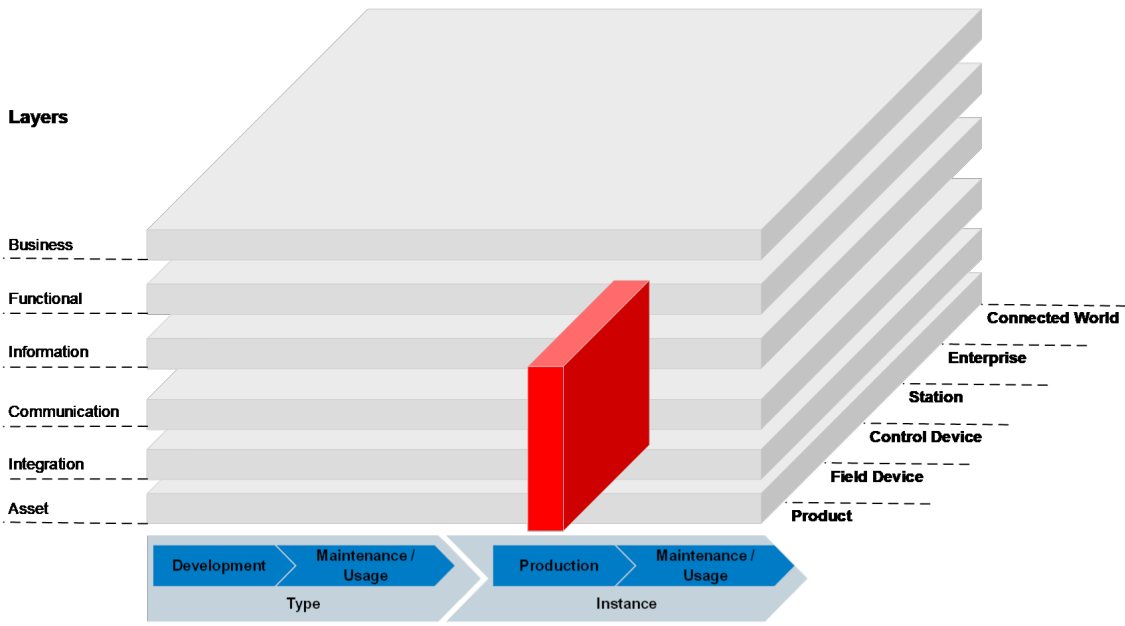

Fig.24 Position of the Smart Energy Project in RAMI 4.0 Model

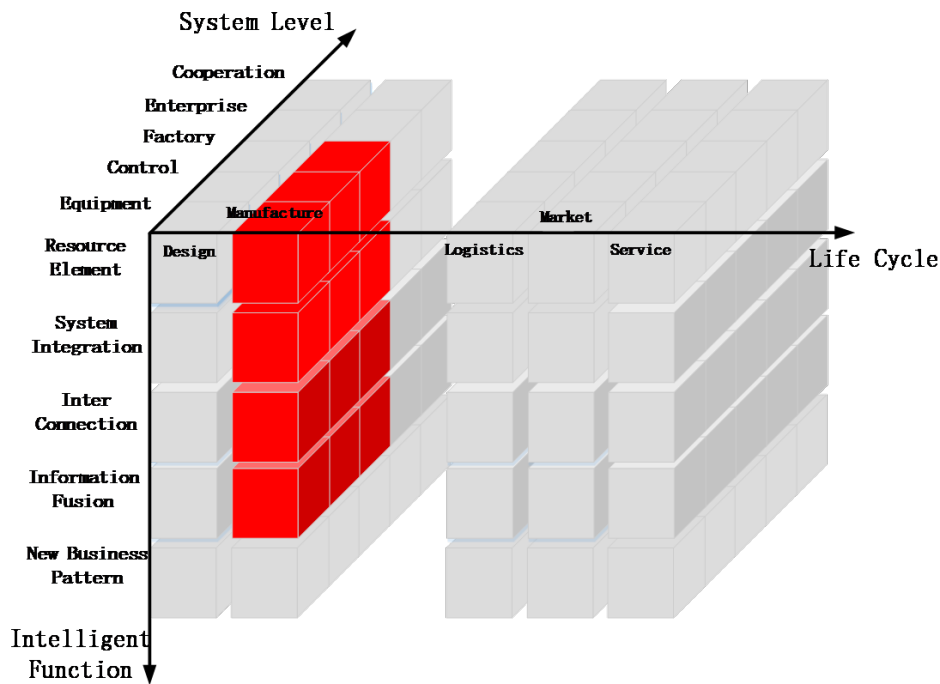

Fig.25 Position of the Smart Energy Project in IMSA

When goes to the reference model of IMSA, on the “System Level” axis, the solution can go to the workshop level (or enterprise level, if consider the interface to diagnostic and energy management system). On the “Intelligent Function” axis, it can reach the information fusion level. On the “Life Cycle” axis, the solution is part of the production phase. The position of the smart energy solution in the reference model of IMSA is as follows.

3.2.3 Equipment Life Cycle Management Project

The concept of the Equipment Life Cycle Management (ELM) is to set up a whole life cycle data management from engineering, construction, operation till maintenance, and build up a simulation module. It provides data support on process simulation, real-time process optimization, new product development and equipment diagnostics. This provides assistance to achieve real-time monitoring/simulation, data integration, sharing and collaboration, and business operations optimization of the physical system to support lean management of the corporation. The final goal is to achieve predictive production.

Baosteel has not yet set up whole life cycle data management from engineering, construction, operation till maintenance. The ELM project is to build up a uniform platform for the consistent digital drawing and intelligent device data base, and based on the intelligent, unique and uniformed data to support intelligent operation and operation. During the implementation of the project, we should explore the engineering data template for metal industry and make preparation for the digital handover. The system architecture of the solution is as follows.

The ELM project is to implement a platform, in the model of RAMI4.0, on the “Layers” axis, it can reach “Information” level and on the “Hierarchy” axis, it can reach control device level. But for the “Life Cycle” axis, the platform can cover design and maintenance two dimensions, it’s not reasonable in this axis.

When goes to the reference model of IMSA, on the “System Level” axis, the platform can goes to control level and on the “Intelligent Function” axis, the platform can reach to system integration level. On the “Life Cycle” axis, the platform cover design and service two dimensions.

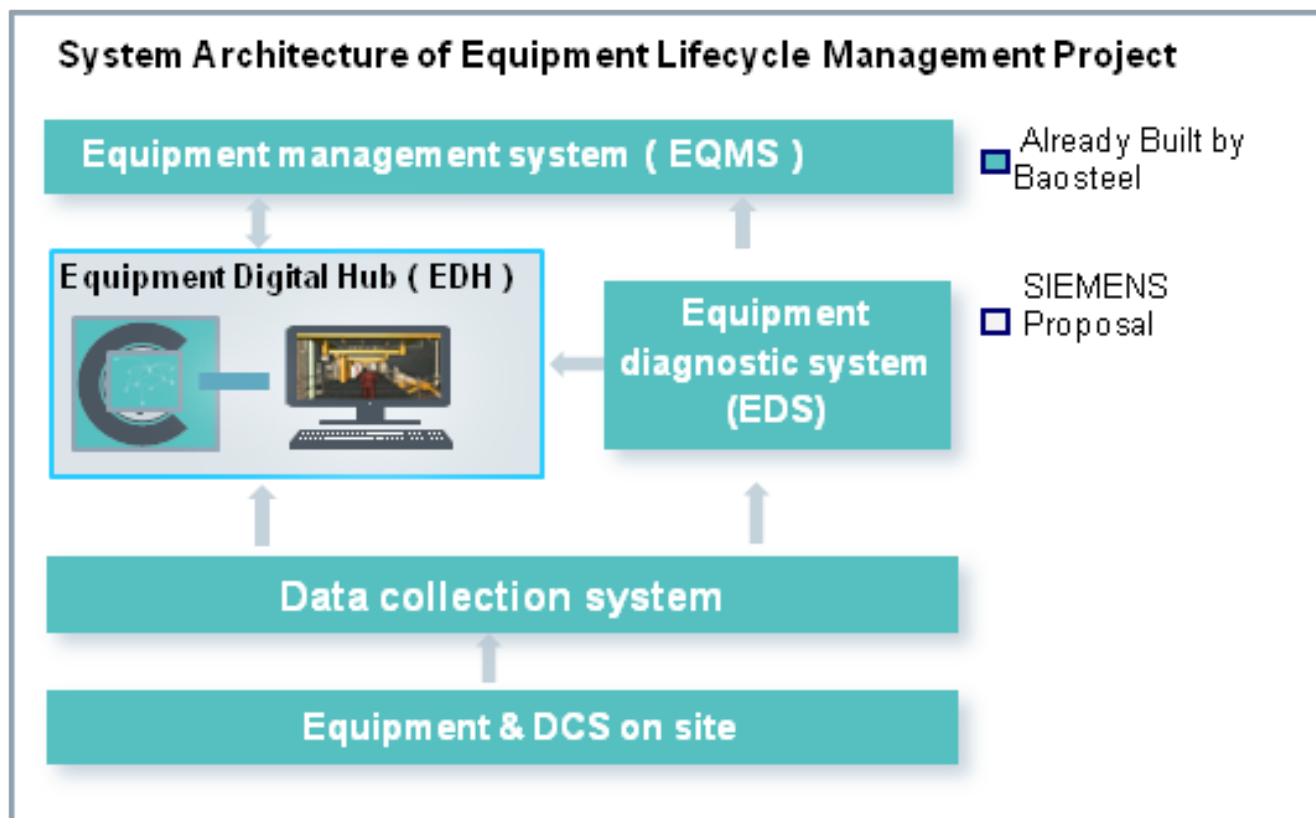

Fig.26 System Architecture of Equipment Lifecycle Management Project

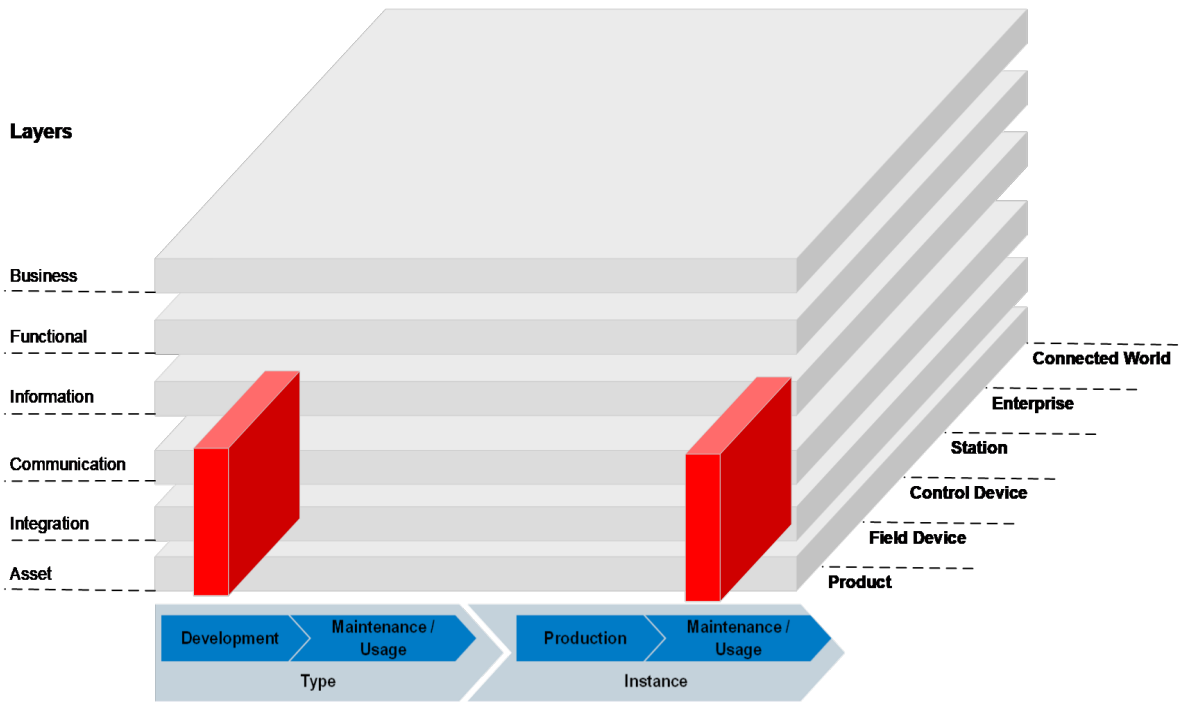

Fig.27 Position of the Equipment Life Cycle Management Project in RAMI 4.0 Model

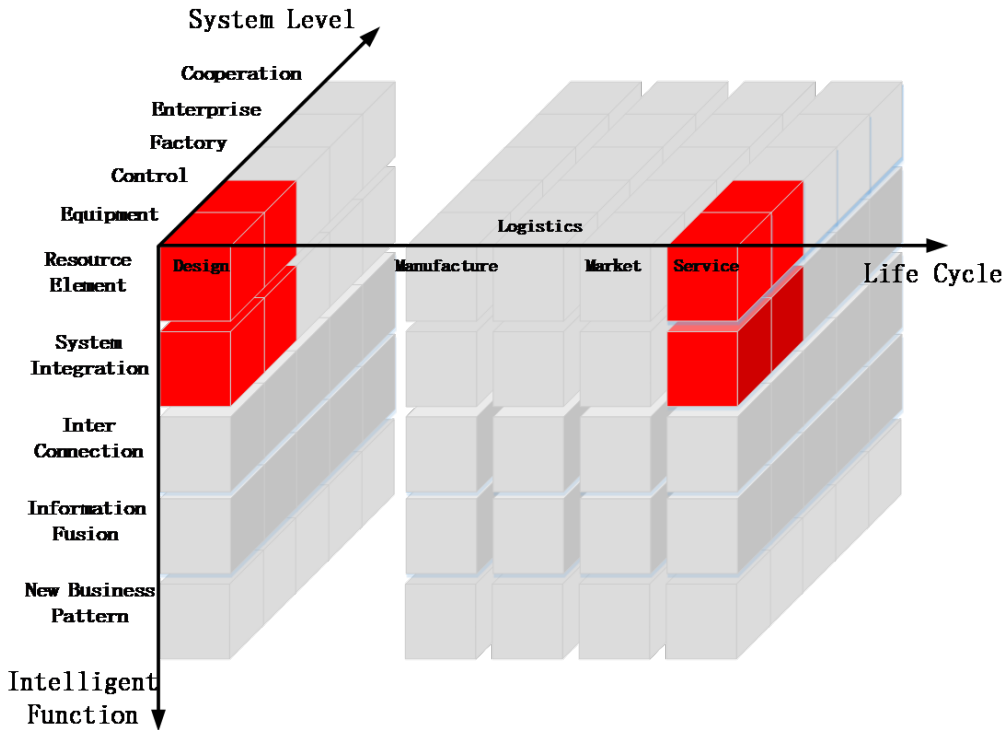

Fig.28 Position of the Equipment Life Cycle Management Project in IMSA

3.3 Conclusions

Above all, in the 3 cases, we can see that if we mapping the “System Level” axis to “Hierarchy” axis, and “Intelligent Function” axis to “Layers” axis, these two dimensions can happily match, but how to match the life cycle dimension need to be discussed.

On “Value stream & Life Cycle” dimension, the RAMI4.0 model defines two main phases, the Type and the Instance, the type phase mainly focus on the process of design and the instance phase mainly focus on the process of manufacturing, thus to say instance phase mainly focus on the realization of the type.

While, the reference model of IMSA divides the life cycle axis to 5 dimensions, but it didn’t specify whether we should see it on the “Product” view or the “Production” view. In discrete industry this two views maybe the same. But in process industry, from the view of product, the design means design of the products, it will be done by product researcher in the lab. But from the view of production, it means the design of the production process or devices, it’s done by designing institute.

So, on “Value stream & Life Cycle” dimension, both RAMI4.0 model and the reference model of IMSA needs to be specified.

Members Sino-German Experts Working Group:

Standardization Council Industrie 4.0 (SCI4.0)

Dr. Jens Gayko, Managing Director SCI4.0

E-Mail: jens.gayko@vde.com

Yves Leboucher, Manager International Cooperations

E-Mail: yves.leboucher@vde.com

Chinese Lead Experts

Dr. WEI Sha, China Electronics Standardization Institute (CESI)

Dr. WANG Chunxi, Instrumentation Technology and Economy Institute (ITEL)

German Lead Experts

Martin Hankel, Bosch Rexroth

Frank Schewe, Phoenix Contact

Dr. Michael Hoffmeister, Festo

PAN Xuelong, Phoenixcontact China

CHEN Jiangning, Siemens Ltd. China

ZHAO Haitao, Siemens Ltd. China

